

SWAROVSKI

LUMINAIRES AND
LIGHTING SYSTEMS

PRICELIST



LUMINAIRES AND
LIGHTING SYSTEMS

PRICELIST

LUMINAIRES	 Ceiling luminaires	 Pendant luminaires	 Wall luminaires	 Recessed Floor Lights	Page
CRYSTAL REFLECTOR, Sinar	■	■	■		6 – 8
CRYSTAL PLATO, Octa	■	■			8 – 9
CRYSTAL EXPRESSION, Madison, Urbic	■	■	■		10 – 11
CRYSTAL IMPRESSION, Downsquare	■				12
CRYSTAL FAME, Circle		■			13
CRYSTAL BLOOM, Bloom		■			14
CRYSTAL ATLAS, Atlas, Atlas Select	■	■	■		14 – 15
CRYSTAL VAILA, Vaila	■				15
CRYSTAL VEGA, Vega crystal, Vega crystal AB Z	■				16
CRYSTAL ICE, Ice Color, Ice Springtime, Ice Crystal, Ice Breeze, Ice Bordeaux, Ice Sunset	■				16
CRYSTAL ATTRACTION, Noblesse, Elegance, Turns, Ringlet	■				17 – 18
CRYSTAL DECO, Sol, Cube, Alba, Sphere, Vial	■				18
CRYSTAL 4 REFLEX, Melody, Funtasy, Breath	■				18
CRYSTAL SUPREME, View, Reflect	■				19
CRYSTAL MOVE, Flame, Rainbow, Dynamic	■				19
CRYSTAL BOOGIE, Pyramide, Ball	■				20
CRYSTAL FELLOW, Turnaround, Temper	■				20
CRYSTAL SPOTS, Fana, Avana, Diona, Tabea	■				21 – 22
CRYSTAL FLAIR, Splendid, Matrix, Wave			■		22
CRYSTAL MOSAIX, Mosaix		■	■		23 – 24
CRYSTAL GLANCE, Verve		■	■		25
CRYSTAL DIVINE, Eyris		■	■		26
CRYSTAL RHYTHM, Samba, Rock, Tango, Swing Power LED, Swing RGB, Swing, Jazz, Jazz RGB				■	27



SETS FOR LED LIGHTING SYSTEMS	Page
----------------------------------	------

CRYSTAL StarLED, Anima, Desire, Relax, Spirit, Pleasure, Delight	28 – 29
---	---------

CRYSTAL StarLED DELUXE, Grace, Glory, Glamour, Alpha, Beta, Gamma, Delta	29 – 31
---	---------

SETS FOR FIBER OPTIC LIGHTING SYSTEMS	Page
--	------

CRYSTAL STARRY SKY, Orion, Galaxy, Universe, Stardust	32 – 33
--	---------

ARCHITECTURAL ELEMENTS	Page
------------------------	------

CRYSTAL Panels	34 – 35
----------------	---------

CRYSTAL Signs	36 – 39
---------------	---------

ACCESSORIES & COMPONENTS FOR INDIVIDUAL LIGHTING DESIGN	Page
--	------

LUMINAIRES, accessories	40 – 41
-------------------------	---------

LED LIGHTING SYSTEMS Crystal StarLED (Light fixtures, distribution module, power supply, accessories)	42 – 45
Crystal StarLED Deluxe (Light fixtures, distribution module, power supply, accessories)	

FIBER OPTIC LIGHTING SYSTEMS Light fixtures, mounting accessories, light guides, light projectors, accessories	46 – 54
---	---------

APPENDIX	Page
----------	------

Pictograms	55
SWAROVSKI worldwide	56
General Terms and Conditions	56



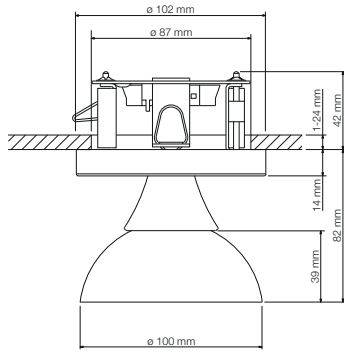

SINAR 100 mm
Recessed ceiling luminaire

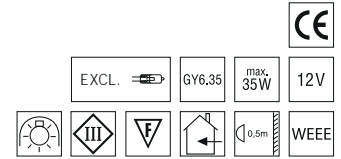

Product	Article number A.9950 NR ...	Version	Price EUR
SINAR 100 mm	700 310	gold-greige	460.00
	700 320	chrome-chrome matte	460.00

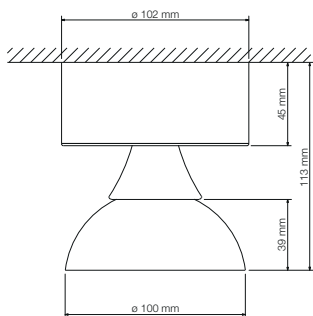

SINAR 100 mm
Surface-mounted ceiling luminaire

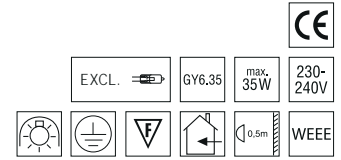

Product	Article number A.9950 NR ...	Version	Price EUR
SINAR 100 mm	700 311	gold-greige	490.00
	700 321	chrome-chrome matte	490.00

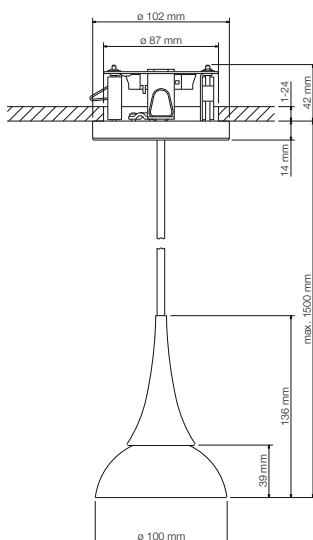

SINAR 100 mm
Recessed pendant luminaire

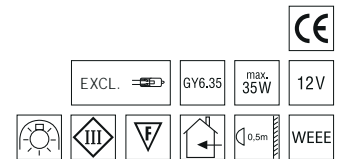

Product	Article number A.9950 NR ...	Version	Price EUR
SINAR 100 mm	700 312	gold-greige	520.00
	700 322	chrome-chrome matte	520.00



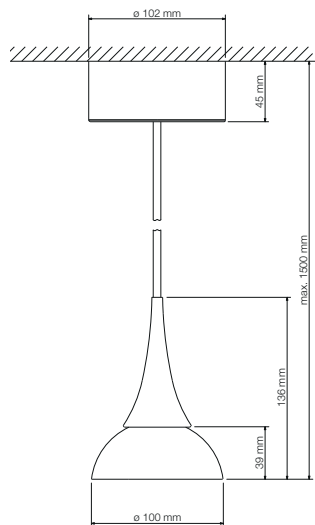

SINAR 100 mm
Surface-mounted pendant luminaire

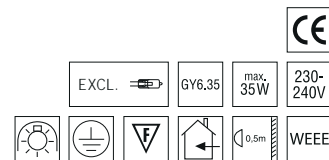

Product	Article number A.9950 NR ...	Version	Price EUR
SINAR 100 mm	700 313	gold-greige	548.00
	700 323	chrome-chrome matte	550.00

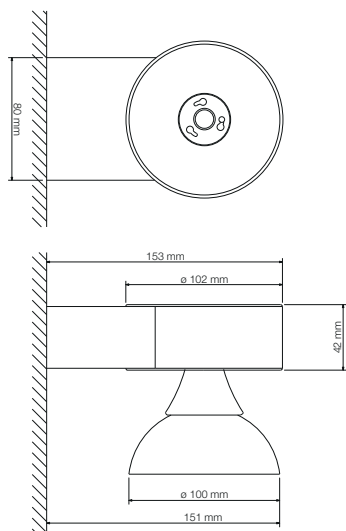

SINAR 100 mm
Surface-mounted wall luminaire

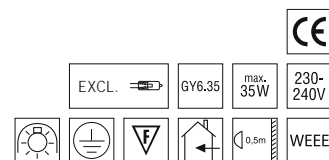

Product	Article number A.9950 NR ...	Version	Price EUR
SINAR 100 mm	700 314	gold-greige	490.00
	700 324	chrome-chrome matte	490.00



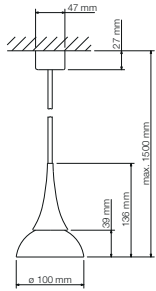

SINAR 100 mm

Surface-mounted pendant luminaire, 3 lights

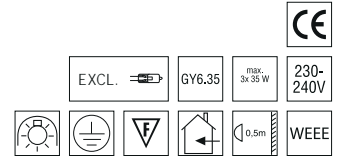

Product	Article number	Version	Price EUR
	A.9950 NR ...		
SINAR 100 mm	700 315	gold-greige	1,490.00
	700 325	chrome-chrome matte	1,490.00

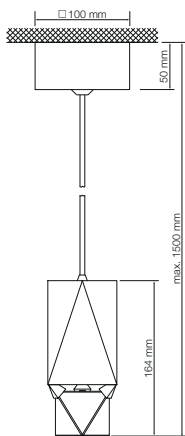
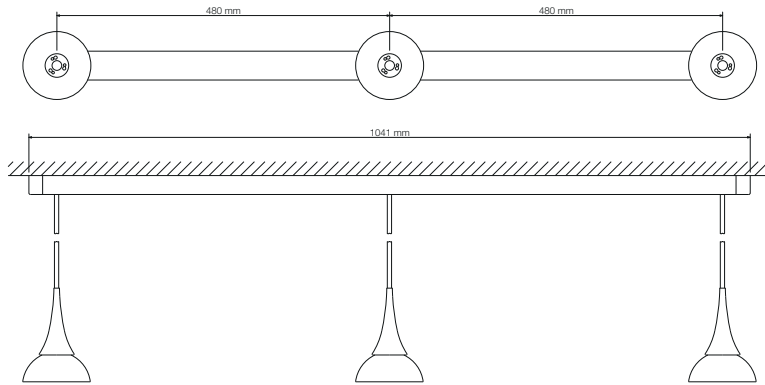

OCTA 60 mm

Surface-mounted pendant luminaire

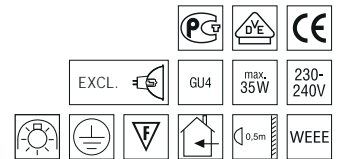

Product	Article number	Version	Price EUR
	A.9950 NR ...		
OCTA 60 mm	700 122	black	388.00
	700 123	white	388.00



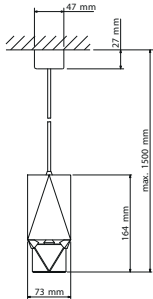

OCTA 60 mm

Surface-mounted pendant luminaire, 3 lights

Product	Article number	Version	Price EUR
	A.9950 NR ...		
OCTA 60 mm	700 128	black	990.00
	700 129	white	990.00

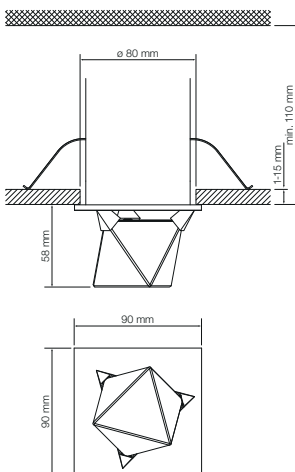
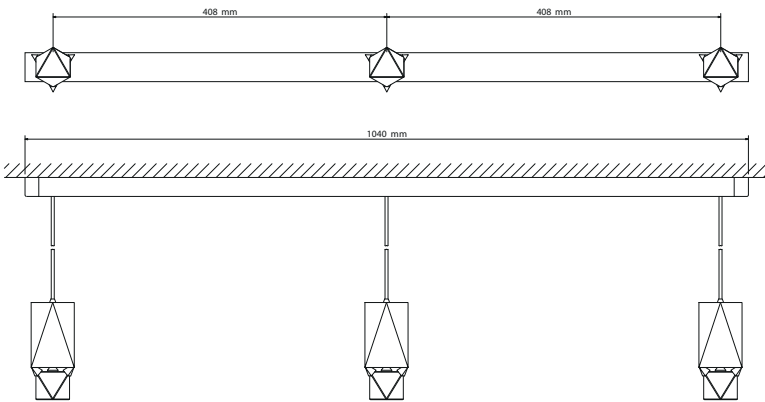
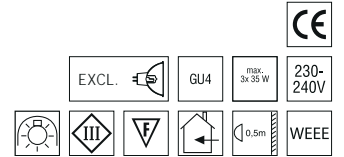

OCTA 60 mm

Recessed ceiling luminaire

Product	Article number	Version	Price EUR
	A.9950 NR ...		
OCTA 60 mm	700 120	chrome	275.00
	700 121	white	275.00

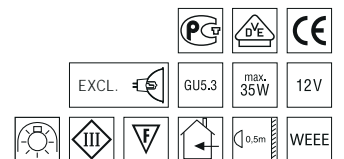

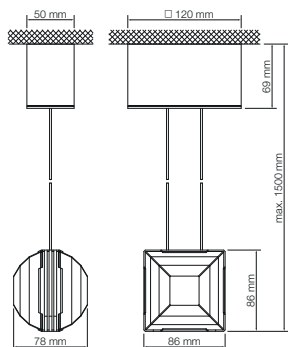

MADISON 80 mm

Surface-mounted pendant luminaire

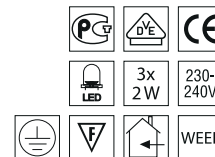

Product	Article number	Version	Light color	Price EUR
	A.9945 NR ...			
MADISON 80 mm	700 196	black	warm white (approx. 3.000 K)	739.00
	700 197	white	warm white (approx. 3.000 K)	739.00

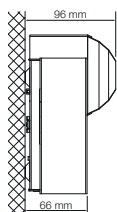

MADISON 80 mm

Surface-mounted wall luminaire

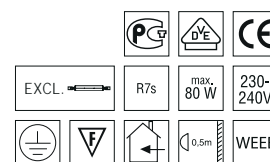

Product	Article number	Version	Price EUR
	A.9950 NR ...		
MADISON 80 mm	700 181	black	376.00
	700 180	white	376.00

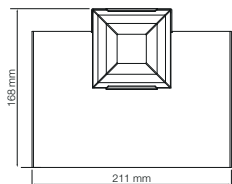

MADISON 80 mm

Recessed ceiling luminaire

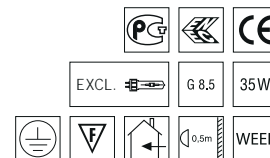

Product	Article number	Version	Price EUR
	A.9950 NR ...		
MADISON 80 mm	700 170	gold-plated	357.00
	700 171	chrome	357.00
	700 173	white	357.00

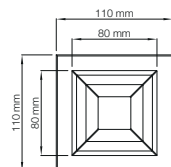
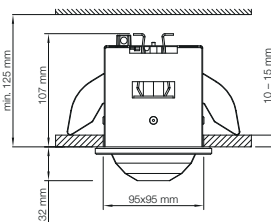

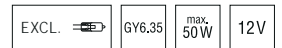
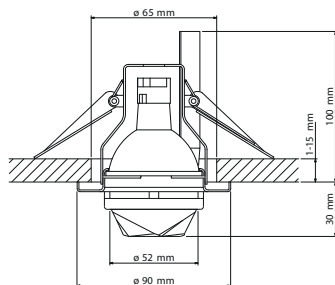
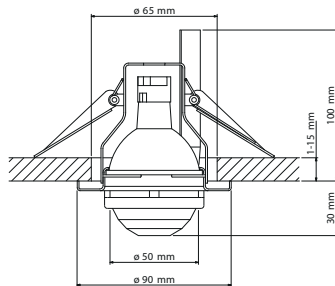
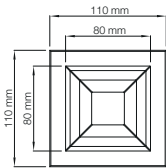
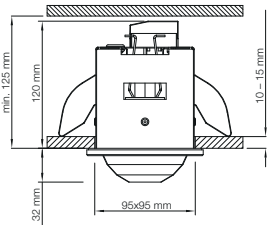

MADISON 80 mm

Recessed ceiling luminaire

Product	Article number	Version	Price EUR
	A.9950 NR ...		
MADISON 80 mm	700 174	gold-plated	336.00
	700 175	chrome	336.00
	700 172	white	336.00



MADISON 50 mm

Recessed ceiling luminaire

Product	Article number	Version	Price EUR
	A.9950 NR ...		
MADISON 50 mm	700 169	chrome	120.00



URBIC

Recessed ceiling luminaire

Product	Article number	Version	Price EUR
	A.8992 NR ...		
URBIC	040 105	chrome	150.00



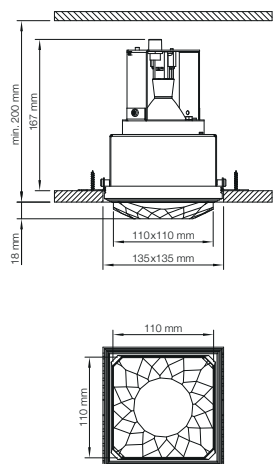

DOWNSQUARE

Recessed ceiling luminaire

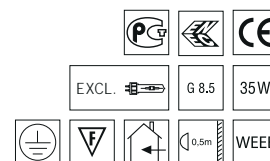

Product	Article number	Version	Price EUR
DOWNSQUARE	A.9950 NR ...	700 150	567.00
		frameless HID recessed ceiling luminaire	

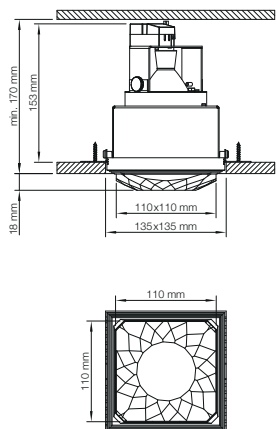

DOWNSQUARE

Recessed ceiling luminaire

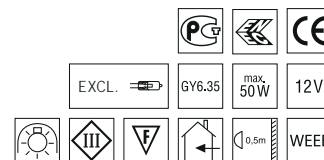

Product	Article number	Version	Price EUR
DOWNSQUARE	A.9950 NR ...	700 152	546.00
		frameless recessed ceiling luminaire	





CIRCLE

Surface-mounted pendant luminaire

Product	Article number A.9943 NR ...	Version	Price EUR
CIRCLE Ø 315 mm	000 115	Stainless steel anthracite-grey	1,680.00
Ø 450 mm	000 116	Stainless steel anthracite-grey	2,300.00
Ø 630 mm	000 117	Stainless steel anthracite-grey	2,960.00

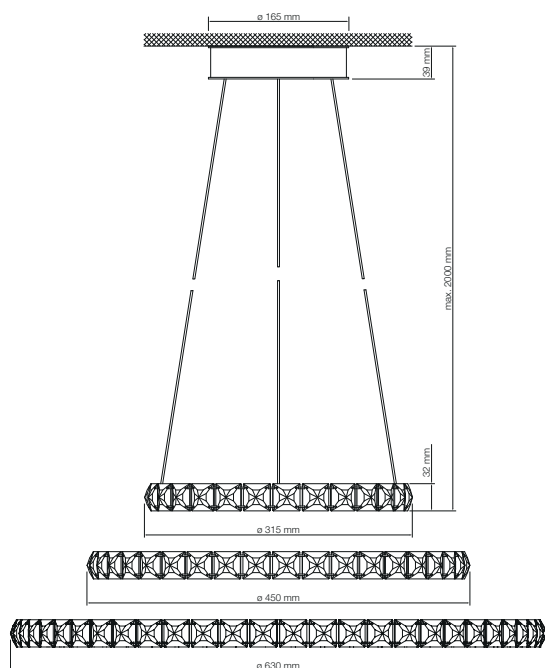

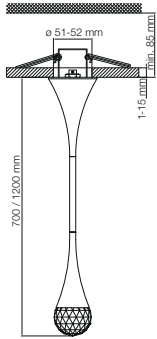

CRYSTAL BLOOM PowerLED

Recessed pendant luminaire with tubular pendant

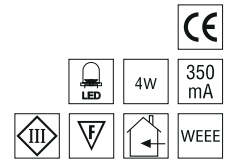

Product	Article number A.9945 NR ...	Version	Light color	Price EUR
BLOOM 700 mm	300 000	chrome	warm white (approx. 3.000K)	419.00
BLOOM 1.200 mm	300 001	chrome	warm white (approx. 3.000K)	429.00

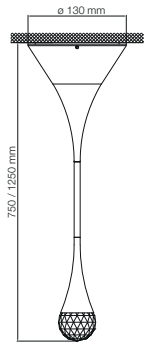

CRYSTAL BLOOM PowerLED

Surface-mounted pendant luminaire with tubular pendant

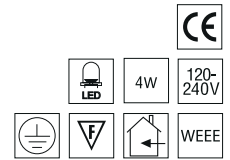

Product	Article number A.9945 NR ...	Version	Light color	Price EUR
BLOOM 750 mm	300 002	chrome	warm white (approx. 3.000K)	499.00
BLOOM 1.250 mm	300 003	chrome	warm white (approx. 3.000K)	519.00

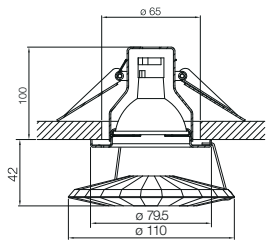

ATLAS

Recessed downlight

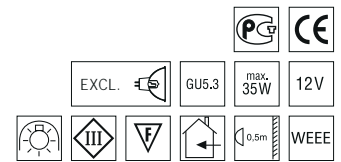

Product	Article number A.8992 NR ...	Version	Price EUR
ATLAS crystal	030 009	gold-plated	122.00
	020 009	chrome	122.00
	040 009	chrome matte	122.00
ATLAS crystal AB	030 009 AB	gold-plated	145.00
	020 009 AB	chrome	145.00
	040 009 AB	chrome matte	145.00
ATLAS moon	030 009 MOON	gold-plated	149.00
	020 009 MOON	chrome	149.00
	040 009 MOON	chrome matte	149.00
ATLAS jet	030 009 JET	gold-plated	155.00
	020 009 JET	chrome	155.00
	040 009 JET	chrome matte	155.00



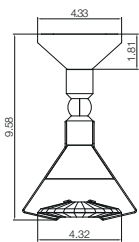

ATLAS SELECT

Surface-mounted ceiling luminaire

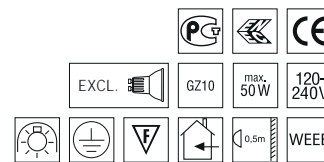

Product	Article number A.9950 NR ...	Version	Price EUR
ATLAS select crystal	600 030	chrome	491.00
ATLAS select crystal AB	600 031	chrome	506.00
ATLAS select moon	600 032	chrome	531.00

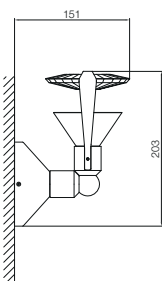

ATLAS SELECT

Surface-mounted wall luminaire

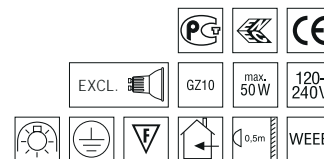

Product	Article number A.9950 NR ...	Version	Price EUR
ATLAS select crystal	600 030	chrome	491.00
ATLAS select crystal AB	600 031	chrome	506.00
ATLAS select moon	600 032	chrome	531.00

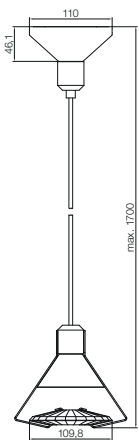

ATLAS SELECT

Pendant lamp

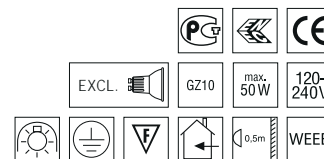

Product	Article number A.9950 NR ...	Version	Price EUR
ATLAS select crystal	600 040	chrome	459.00
ATLAS select crystal AB	600 041	chrome	473.00
ATLAS select moon	600 042	chrome	498.00

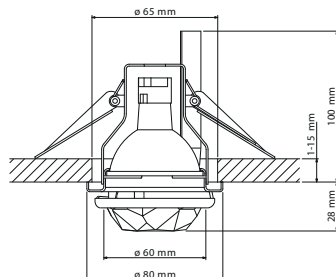

VAILA

Recessed ceiling luminaire



Product	Article number A.8992 NR ...	Version	Price EUR
VAILA	040 100	chrome	135.00



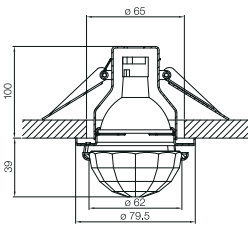

VEGA

Recessed downlight

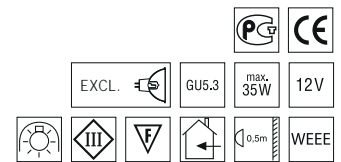

Product	Article number A.8992 NR ...	Version	Price EUR
VEGA crystal	030 010	gold-plated	80.70
	020 010	chrome	80.70
	040 010	chrome matte	80.70
VEGA crystal AB „Z“	030 010 AB „Z“	gold-plated	84.20
	020 010 AB „Z“	chrome	84.20
	040 010 AB „Z“	chrome matte	84.20

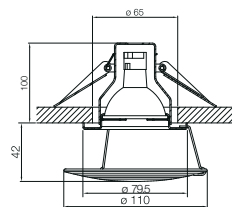

ICE

Recessed downlight

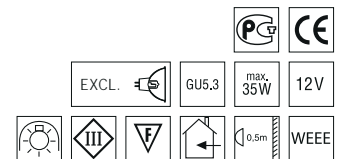

Product	Article number A.8992 NR ...	Version	Price EUR
ICE COLOR crystal AB	030 015	gold-plated	102.00
	020 015	chrome	102.00
	040 015	chrome matte	102.00
ICE SPRINGTIME antique green	030 018	gold-plated	147.00
	020 018	chrome	147.00
	040 018	chrome matte	147.00
ICE CRYSTAL	030 014	gold-plated	99.50
	020 014	chrome	99.50
	040 014	chrome matte	99.50
ICE BREEZE medium sapphire	030 016	gold-plated	147.00
	020 016	chrome	147.00
	040 016	chrome matte	147.00
ICE BORDEAUX crystal/bordeaux rot	030 030	gold-plated	147.00
	020 030	chrome	147.00
	040 030	chrome matte	147.00
ICE MENTALITY rosaline	030 019	gold-plated	147.00
	020 019	chrome	147.00
	040 019	chrome matte	147.00
ICE SUNSET crystal/light topaz	030 017	gold-plated	147.00
	020 017	chrome	147.00
	040 017	chrome matte	147.00



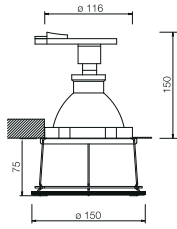

NOBLESSE

Recessed ceiling luminaires

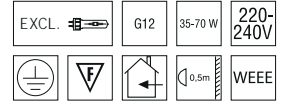

Product	Article number A.8992 NR ...	Version	Price EUR
NOBLESSE crystal 35 W	000 104	white	428.00
	000 204	chrome	428.00
	000 304	gold-plated	428.00
NOBLESSE crystal 70 W	000 105	white	428.00
	000 205	chrome	428.00
	000 305	gold-plated	428.00

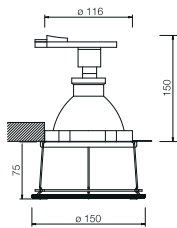

ELEGANCE

Recessed ceiling luminaires

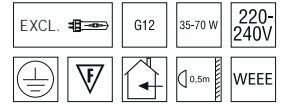

Product	Article number A.8992 NR ...	Version	Price EUR
ELEGANCE crystal 35 W	000 100	white	392.00
	000 200	chrome	392.00
	000 300	gold-plated	392.00
ELEGANCE crystal 70 W	000 102	white	392.00
	000 202	chrome	392.00
	000 302	gold-plated	392.00
ELEGANCE crystal AB 35 W	000 101	white	404.00
	000 201	chrome	404.00
	000 301	gold-plated	404.00
ELEGANCE crystal AB 70 W	000 103	white	404.00
	000 203	chrome	404.00
	000 303	gold-plated	404.00

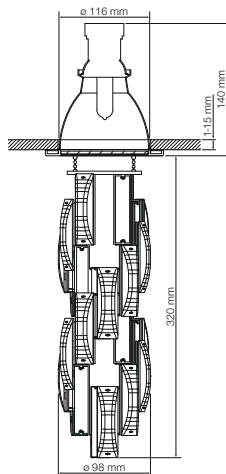

TURNS

Recessed ceiling luminaire

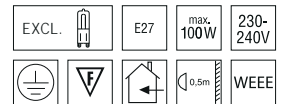

Product	Article number A.9950 NR ...	Version	Price EUR
TURNS	700 239	chrome	765.00



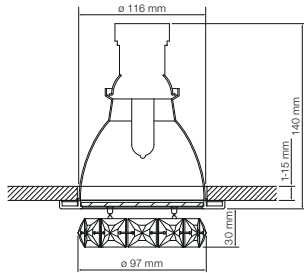

RINGLET

Recessed ceiling luminaire

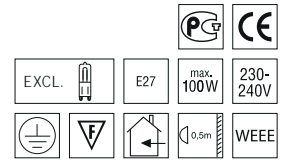

Product	Article number A.9950 NR ...	Version	Price EUR
RINGLET	700 238	chrome	337.00

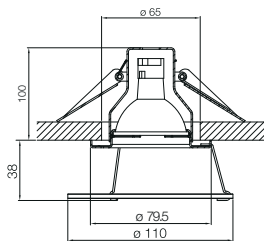

SOL, CUBE, ALBA, SPHERE, VIAL

Recessed downlights

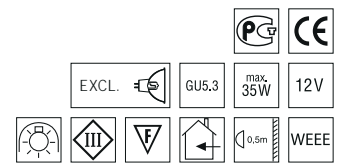

Product	Article number A.8992 NR ...	Version	Price EUR
SOL	030 005	gold-plated	87.70
	020 005	chrome	87.70
	040 005	chrome matte	87.70
CUBE	030 025	gold-plated	117.00
	020 025	chrome	117.00
	040 025	chrome matte	117.00
ALBA	030 001	gold-plated	73.70
	020 001	chrome	73.70
	040 001	chrome matte	73.70
SPHERE	030 027	gold-plated	128.00
	020 027	chrome	128.00
	040 027	chrome matte	128.00
VIAL	030 007	gold-plated	92.50
	020 007	chrome	92.50
	040 007	chrome matte	92.50

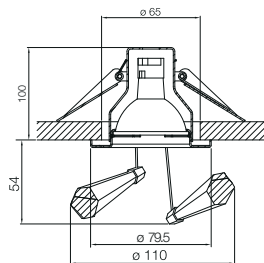

MELODY, FUNTASY, BREATH

Recessed downlights

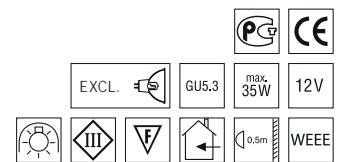

Product	Article number A.8992 NR ...	Version	Price EUR
MELODY crystal AB/crystal	500 301	gold-plated	122.00
	500 311	chrome	122.00
	500 321	chrome matte	122.00
FUNTASY crystal/topaz	500 100	gold-plated	116.00
	500 110	chrome	116.00
	500 120	chrome matte	116.00
BREATH crystal/sapphire	500 001	gold-plated	116.00
	500 011	chrome	116.00
	500 021	chrome matte	116.00



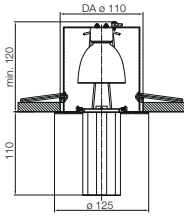

VIEW

Recessed ceiling luminaire

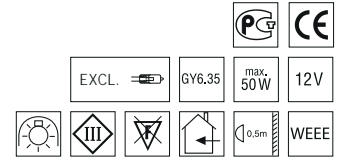

Product	Article number	Version	Price EUR
VIEW crystal	A.9950 NR ... 700 000	Stainless steel, aluminum reflector	466.00

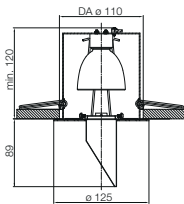

REFLECT

Recessed ceiling luminaire

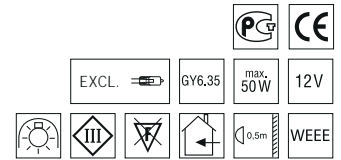

Product	Article number	Version	Price EUR
REFLECT crystal	A.9950 NR ... 700 100	Stainless steel, aluminum reflector	504.00

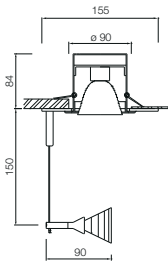

FLAME

Recessed downlight

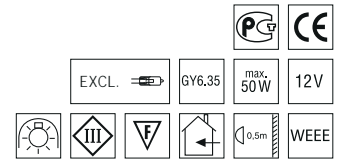

Product	Article number	Version	Price EUR
FLAME	A.9950 NR ... 610 022	Titan silver/Brushed aluminum, aluminum reflector	379.00

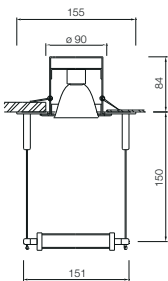

RAINBOW

Recessed downlight

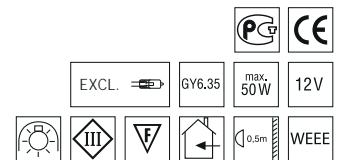

Product	Article number	Version	Price EUR
RAINBOW	A.9950 NR ... 620 022	Titan silver/Brushed aluminum, aluminum reflector	494.00

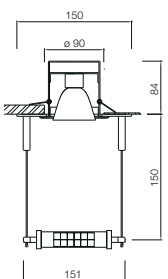

DYNAMIC

Recessed downlight

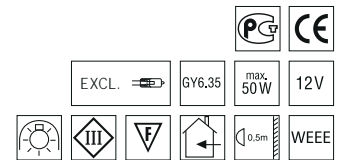

Product	Article number	Version	Price EUR
DYNAMIC	A.9950 NR ... 620 042	Titan silver/Brushed aluminum, aluminum reflector	521.00



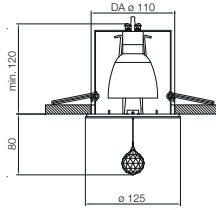

BALL

Recessed ceiling luminaires

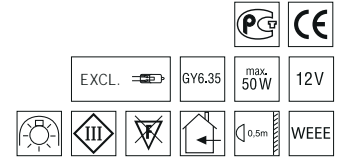

Product	Article number A.9950 NR ...	Version	Price EUR
BALL	650 002	Titan silver, aluminum reflector	240.00
	A.8992 NR ...		
	650 002	Stainless steel, aluminum reflector	240.00

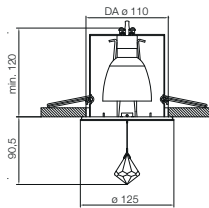

PYRAMIDE

Recessed ceiling luminaires

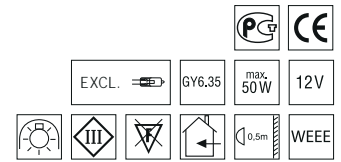

Product	Article number A.9950 NR ...	Version	Price EUR
PYRAMIDE	650 012	Titan silver, aluminum reflector	240.00
	A.8992 NR ...		
	650 012	Stainless steel, aluminum reflector	240.00

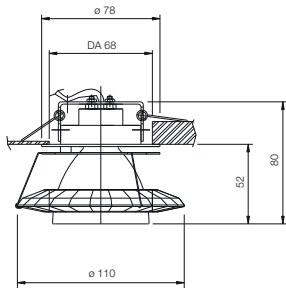

TURNAROUND

Recessed ceiling luminaires

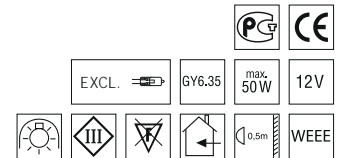

Product	Article number A.9950 NR ...	Version	Price EUR
TURNAROUND crystal	600 002	Brushed aluminum, glass reflector	261.00
TURNAROUND crystal AB	600 003	Brushed aluminum, glass reflector	277.00

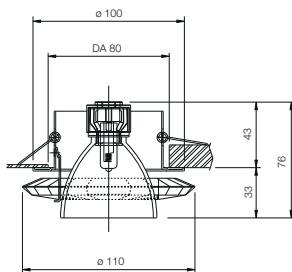

TEMPER

Recessed ceiling luminaires

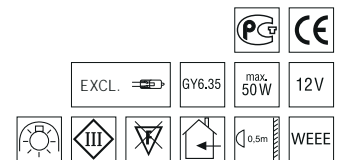

Product	Article number A.9950 NR ...	Version	Price EUR
TEMPER crystal	600 004	Titan silver, glass reflector	263.00
TEMPER crystal AB	600 005	Titan silver, glass reflector	279.00



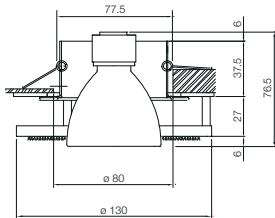

FANA

Recessed ceiling luminaire

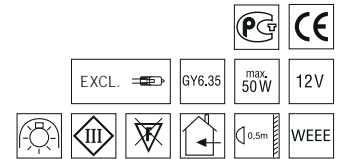

Product	Article number A.9950 NR ...	Version	Price EUR
FANA	180 200	Titan silver / Brushed aluminum, glass reflector	347.00

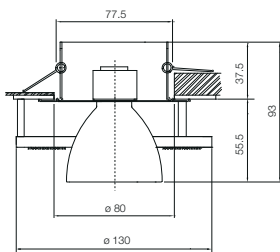

AVANA

Recessed ceiling luminaire

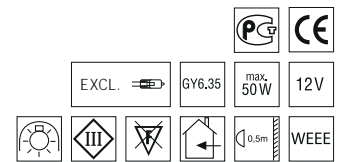

Product	Article number A.9950 NR ...	Version	Price EUR
AVANA	180 100	Titan silver / Brushed aluminum, glass reflector	347.00

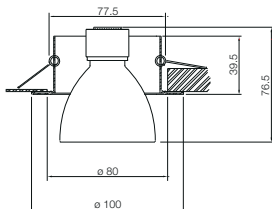

DIONA

Recessed ceiling luminaires

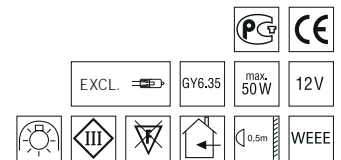

Product	Article number A.9950 NR ...	Version	Price EUR
DIONA translucent	110 500	Reflector protruding, Titan silver	178.00
DIONA satined	110 501	Reflector protruding, Titan silver	178.00

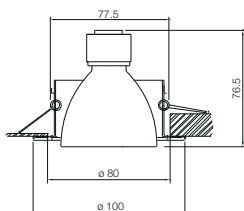

DIONA

Recessed ceiling luminaires

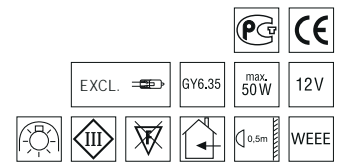

Product	Article number A.9950 NR ...	Version	Price EUR
DIONA translucent	110 200	Reflector flush with ceiling, Titan silver	178.00
DIONA satined	110 201	Reflector flush with ceiling, Titan silver	178.00



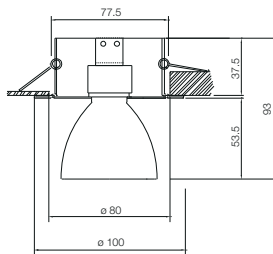

TABEA

Recessed ceiling luminaires

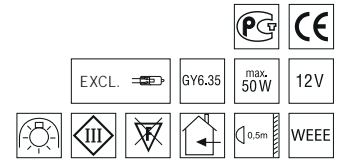

Product	Article number A.9950 NR ...	Version	Price EUR
TABEA translucent	120 200	Without swivel and tilt joint, Titan silver/ Brushed aluminum	178.00
TABEA satined	120 201	Without swivel and tilt joint, Titan silver/ Brushed aluminum	178.00

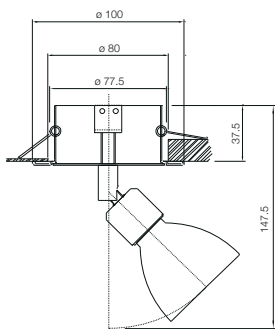

TABEA

Recessed ceiling luminaires

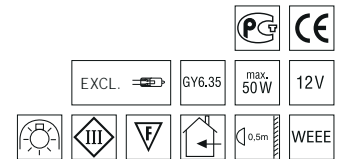

Product	Article number A.9950 NR ...	Version	Price EUR
TABEA translucent	120 500	With swivel and tilt joint, Titan silver/ Brushed aluminum	233.00
TABEA satined	120 501	With swivel and tilt joint, Titan silver/ Brushed aluminum	233.00

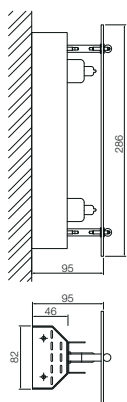

SPLENDID, MATRIX, WAVE

Surface-mounted wall luminaires

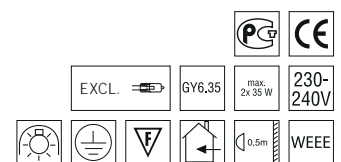

Product	Article number A.9360 NR ...	Version	Price EUR
SPLENDID light topaz	130 011	Brushed stainless steel	322.00
SPLENDID crystal AB	120 011	Brushed stainless steel	322.00
SPLENDID crystal	110 011	Brushed stainless steel	322.00
MATRIX	050 011	Brushed stainless steel	322.00
WAVE	020 011	Brushed stainless steel	322.00



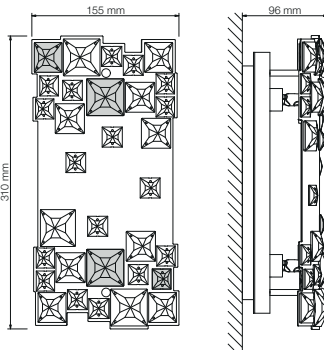
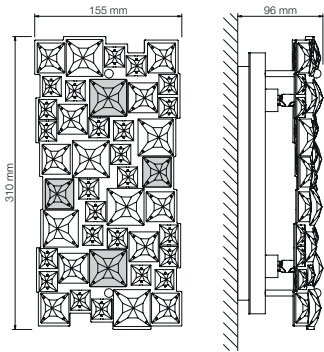

MOSAIX

Surface-mounted wall luminaire

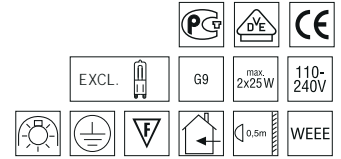

Product	Article number A.9950 NR ...	Version	Price EUR
MOSAIX	700 251	stainless steel	632.00
	700 281	black	580.00
	700 282	white	580.00

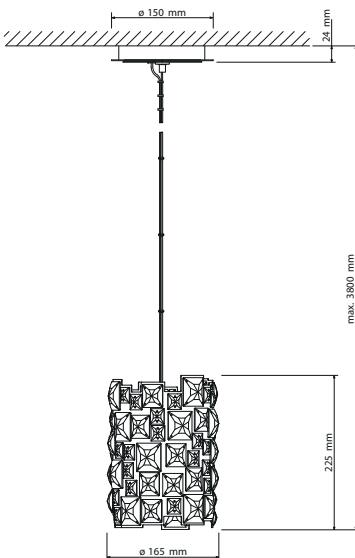

MOSAIX 165 mm

Surface-mounted pendant luminaire

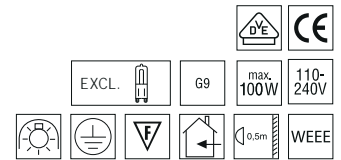

Product	Article number A.9950 NR ...	Version	Price EUR
MOSAIX 165 mm	700 272	stainless steel	1,380.00
	700 273	black	790.00
	700 274	white	790.00



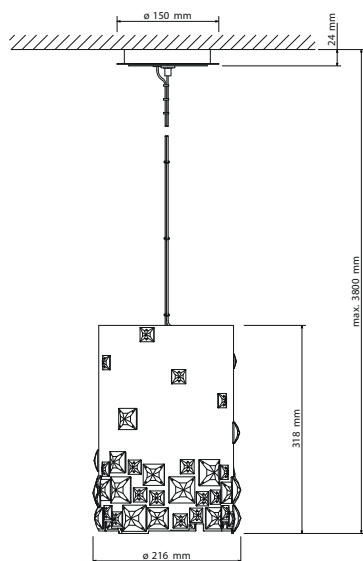

MOSAIX 216 mm
Surface-mounted pendant luminaire

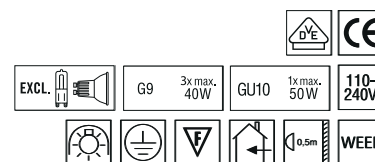

Product	Article number A.9950 NR ...	Version	Price EUR
MOSAIX 216 mm	700 275	stainless steel	2,450.00
	700 276	black	1,350.00
	700 277	white	1,350.00

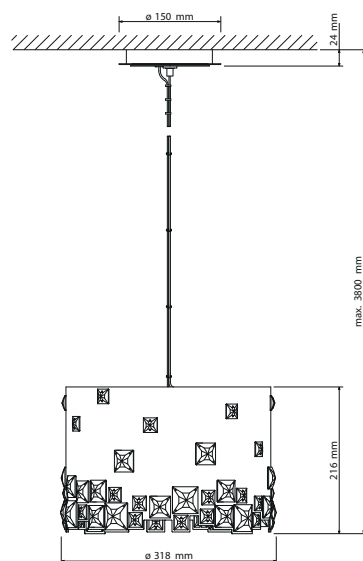

MOSAIX 318 mm
Surface-mounted pendant luminaire

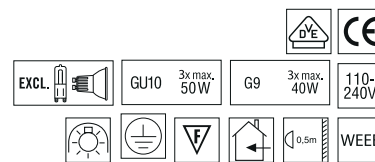

Product	Article number A.9950 NR ...	Version	Price EUR
MOSAIX 318 mm	700 278	stainless steel	2,600.00
	700 279	black	1,710.00
	700 280	white	1,710.00





VERVE

Surface-mounted pendant luminaire

Product	Article number A.9950 NR ...	Version	Price EUR
VERVE 456 mm	700 211	Stainless steel anthracite-grey	1,330.00
VERVE 608 mm	700 213	Stainless steel anthracite-grey	1,480.00

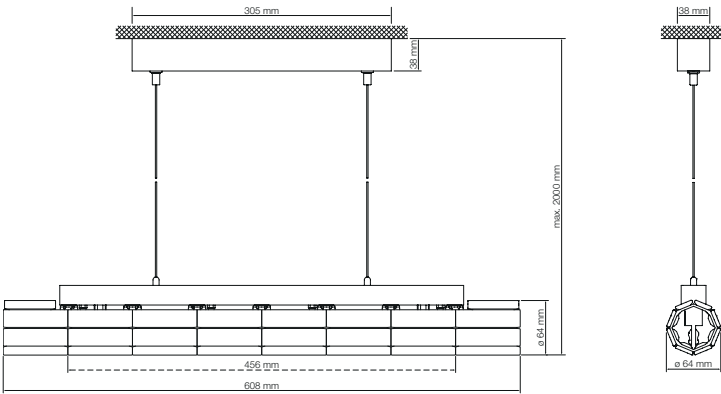

VERVE

Surface-mounted wall luminaire

Product	Article number A.9950 NR ...	Version	Price EUR
VERVE 152 mm	700 210	Stainless steel anthracite-grey	428.00
VERVE 456 mm	700 212	Stainless steel anthracite-grey	1,330.00
VERVE 608 mm	700 214	Stainless steel anthracite-grey	1,480.00

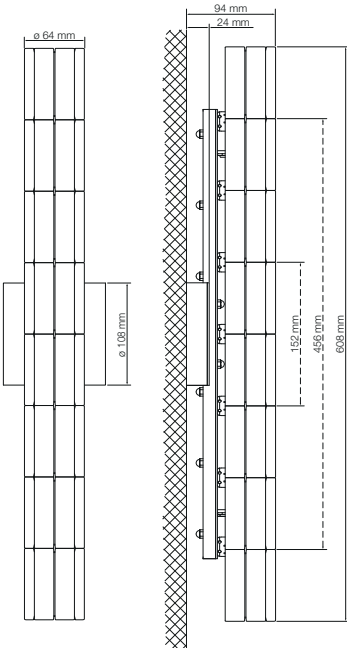

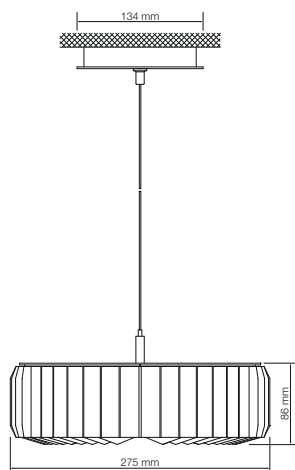

EYRIS duo

Surface-mounted pendant luminaire

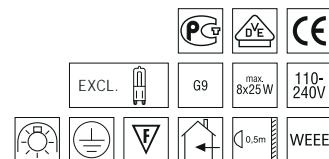

Product	Article number	Version	Price EUR
EYRIS duo	A.9950 NR ... 700 231	Stainless steel anthracite-grey	5,610.00

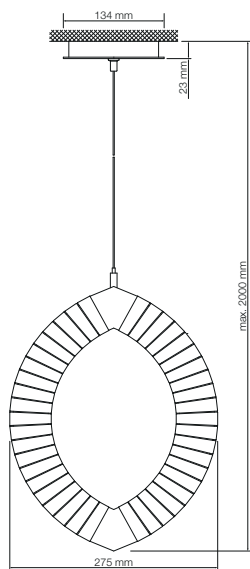

EYRIS mono

Surface-mounted pendant luminaire

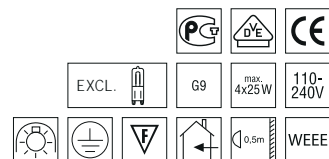

Product	Article number	Version	Price EUR
EYRIS mono	A.9950 NR ... 700 230	Stainless steel anthracite-grey	3,320.00

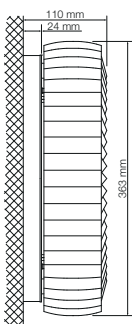

EYRIS

Surface-mounted wall luminaire

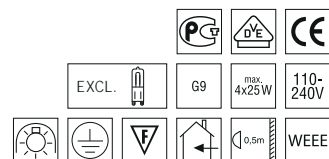

Product	Article number	Version	Price EUR
EYRIS	A.9950 NR ... 700 232	Stainless steel anthracite-grey	3,110.00



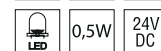
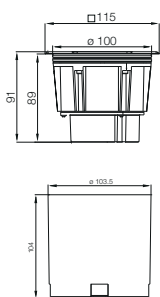
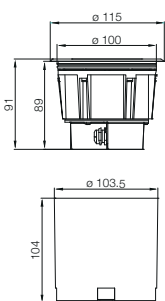
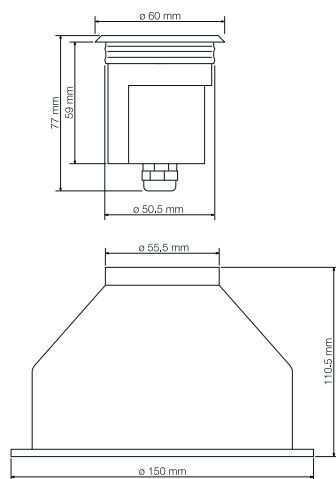

SAMBA, ROCK, TANGO

Recessed floor luminaires

Product	Article number A.9945 NR ...	Version	Crystal color	Price EUR
SAMBA	020 500	Stainless steel V2A	crystal	221.00
ROCK	020 501	Stainless steel V2A	crystal	210.00
TANGO	020 502	Stainless steel V2A	sapphire	210.00



SWING

Recessed floor luminaires

Product	Article number A.9945 NR ...	Version	Price EUR
SWING POWER LED	020 503	Stainless steel V2A, 3 W	387.00

Product	Article number A.9943 NR ...	Version	Price EUR
SWING RGB	000 062	Stainless steel V2A, 1.65 W	424.00
SWING	000 022	Stainless steel V2A, 0.8 W	356.00



JAZZ

Recessed floor luminaires

Product	Article number A.9943 NR ...	Version	Price EUR
JAZZ	000 023	Stainless steel V2A, 1.6 W	400.00
JAZZ RGB	000 063	Stainless steel V2A, 1.65 W	479.00



**ANIMA 6 STARS**

LED Lighting system

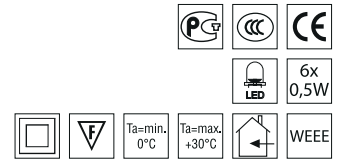

Product	Article number A.9945 NR ...	Version	Light color	Price EUR
ANIMA 6 stars	000 005	nickel-plated	daylight white (approx. 8.000K)	379.00
	000 006	nickel-plated	neutral white (approx. 3.500K)	379.00
	000 001	gold-plated	daylight white (approx. 8.000K)	379.00
	000 002	gold-plated	neutral white (approx. 3.500K)	379.00

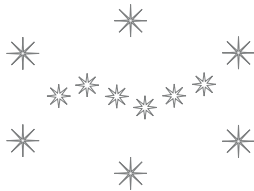
**DESIRE 12 STARS**

LED Lighting system

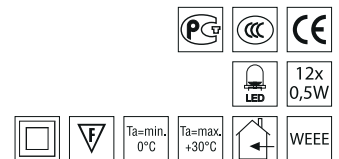

Product	Article number A.9945 NR ...	Version	Light color	Price EUR
DESIRE 12 stars	000 007	nickel-plated	daylight white (approx. 8.000K)	563.00
	000 008	nickel-plated	neutral white (approx. 3.500K)	563.00
	000 003	gold-plated	daylight white (approx. 8.000K)	563.00
	000 004	gold-plated	neutral white (approx. 3.500K)	563.00

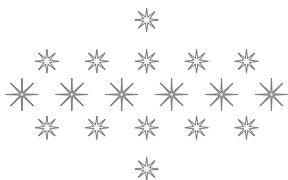
**RELAX 18 STARS**

LED Lighting system

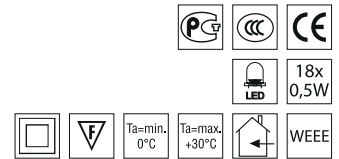

Product	Article number A.9945 NR ...	Version	Light color	Price EUR
RELAX 18 stars	000 009	nickel-plated	daylight white (approx. 8.000K)	729.00
	000 010	nickel-plated	neutral white (approx. 3.500K)	729.00
	000 011	gold-plated	daylight white (approx. 8.000K)	729.00
	000 012	gold-plated	neutral white (approx. 3.500K)	729.00

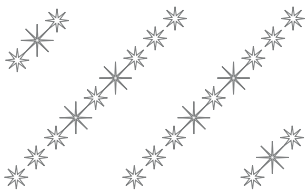
**SPIRIT 24 STARS**

LED Lighting system

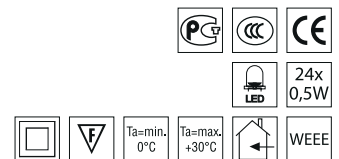

Product	Article number A.9945 NR ...	Version	Light color	Price EUR
SPIRIT 24 stars	000 021	nickel-plated	daylight white (approx. 8.000K)	907.00
	000 022	nickel-plated	neutral white (approx. 3.500K)	907.00
	000 023	gold-plated	daylight white (approx. 8.000K)	907.00
	000 024	gold-plated	neutral white (approx. 3.500K)	907.00



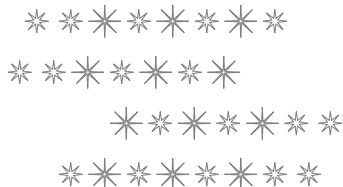

PLEASURE 30 STARS

LED Lighting system

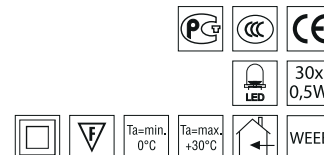

Product	Article number A.9945 NR ...	Version	Light color	Price EUR
PLEASURE 30 stars	000 025	nickel-plated	daylight white (approx. 8.000K)	1,080.00
	000 026	nickel-plated	neutral white (approx. 3.500K)	1,080.00
	000 027	gold-plated	daylight white (approx. 8.000K)	1,080.00
	000 028	gold-plated	neutral white (approx. 3.500K)	1,080.00

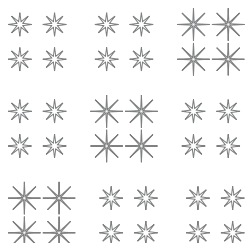

DELIGHT 36 STARS

LED Lighting system

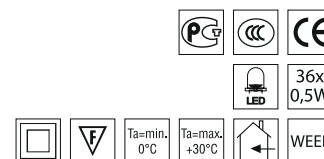

Product	Article number A.9945 NR ...	Version	Light color	Price EUR
DELIGHT 36 stars	000 017	nickel-plated	daylight white (approx. 8.000K)	1,250.00
	000 018	nickel-plated	neutral white (approx. 3.500K)	1,250.00
	000 019	gold-plated	daylight white (approx. 8.000K)	1,250.00
	000 020	gold-plated	neutral white (approx. 3.500K)	1,250.00

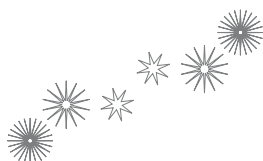

GRACE 6 CRYSTALS

LED Lighting system

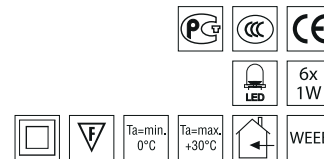

Product	Article number A.9945 NR ...	Version	Light color	Price EUR
GRACE 6 crystals	000 051	chrome-plated	daylight white (approx. 6.700K)	769.00
	000 053	chrome-plated	neutral white (approx. 3.400K)	769.00
	000 050	gold-plated	daylight white (approx. 6.700K)	769.00
	000 052	gold-plated	neutral white (approx. 3.400K)	769.00

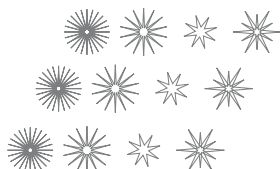

GLORY 12 CRYSTALS

LED Lighting system

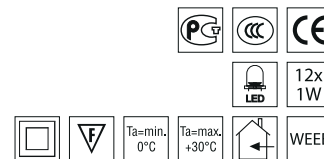

Product	Article number A.9945 NR ...	Version	Light color	Price EUR
GLORY 12 crystals	000 055	chrome-plated	daylight white (approx. 6.700K)	1,380.00
	000 057	chrome-plated	neutral white (approx. 3.400K)	1,380.00
	000 054	gold-plated	daylight white (approx. 6.700K)	1,380.00
	000 056	gold-plated	neutral white (approx. 3.400K)	1,380.00



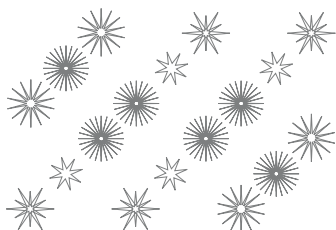

GLAMOUR 18 CRYSTALS

LED Lighting system

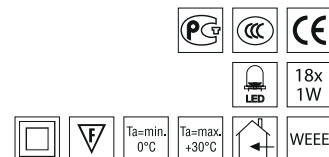

Product	Article number A.9945 NR ...	Version	Light color	Price EUR
GLAMOUR 18 crystals	000 059	chrome-plated	daylight white (approx. 6.700K)	2,000.00
	000 061	chrome-plated	neutral white (approx. 3.400K)	2,000.00
	000 058	gold-plated	daylight white (approx. 6.700K)	2,000.00
	000 060	gold-plated	neutral white (approx. 3.400K)	2,000.00

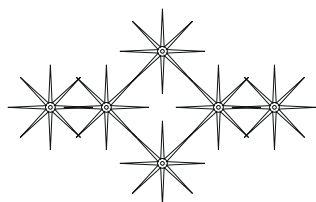

ALPHA 6 CRYSTALS

LED Lighting system

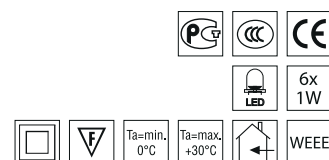

Product	Article number A.9945 NR ...	Version	Light color	Price EUR
ALPHA 6 crystals	000 101	gold-plated	daylight white (approx. 6.700K)	830.00
	000 102	gold-plated	neutral white (approx. 3.400K)	830.00
	000 103	chrome-plated	daylight white (approx. 6.700K)	830.00
	000 104	chrome-plated	neutral white (approx. 3.400K)	830.00

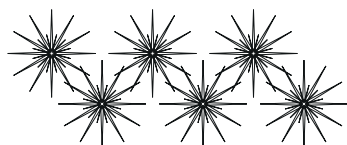

BETA 6 CRYSTALS

LED Lighting system

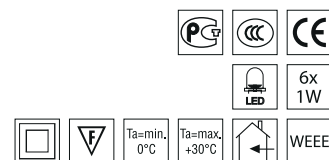

Product	Article number A.9945 NR ...	Version	Light color	Price EUR
BETA 6 crystals	000 111	gold-plated	daylight white (approx. 6.700K)	830.00
	000 112	gold-plated	neutral white (approx. 3.400K)	830.00
	000 113	chrome-plated	daylight white (approx. 6.700K)	830.00
	000 114	chrome-plated	neutral white (approx. 3.400K)	830.00



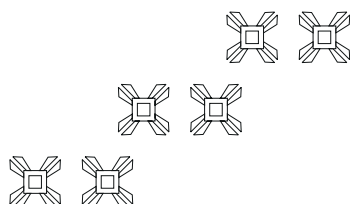

GAMMA 6 CRYSTALS

LED Lighting system

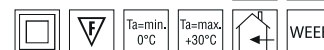

Product	Article number A.9945 NR ...	Version	Light color	Price EUR
GAMMA 6 crystals	000 121	gold-plated	daylight white (approx. 6.700K)	830.00
	000 122	gold-plated	neutral white (approx. 3.400K)	830.00
	000 123	chrome-plated	daylight white (approx. 6.700K)	830.00
	000 124	chrome-plated	neutral white (approx. 3.400K)	830.00

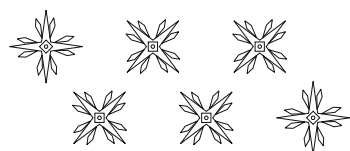

DELTA 6 CRYSTALS

LED Lighting system

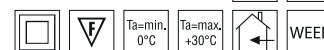

Product	Article number A.9945 NR ...	Version	Light color	Price EUR
DELTA 6 crystals	000 131	gold-plated	daylight white (approx. 6.700K)	830.00
	000 132	gold-plated	neutral white (approx. 3.400K)	830.00
	000 133	chrome-plated	daylight white (approx. 6.700K)	830.00
	000 134	chrome-plated	neutral white (approx. 3.400K)	830.00





ORION 35 STARS

Fiber optic lighting system

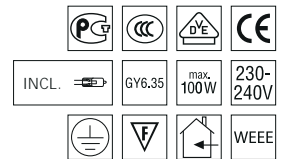

Product	Article number A.9930 NR ...	Version	Light projector	Price EUR
ORION 35 stars	000 901	gold-plated	100 W (halogen)	1,580.00
20 tails à 2 m,	000 902	nickel-plated	100 W (halogen)	1,580.00
15 tails à 3,5 m	000 903	chrome matte	100 W (halogen)	1,580.00
	000 904	white	100 W (halogen)	1,580.00

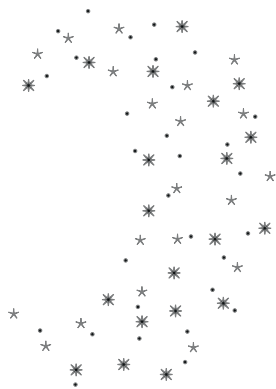

GALAXY 70 STARS

Fiber optic lighting system

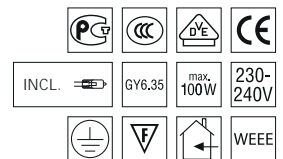

Product	Article number A.9930 NR ...	Version	Light projector	Price EUR
GALAXY 70 stars	001 007	gold-plated	100 W (halogen)	2,340.00
70 tails à 3 m	001 001	nickel-plated	100 W (halogen)	2,340.00
	001 017	chrome matte	100 W (halogen)	2,340.00
	001 018	white	100 W (halogen)	2,340.00
GALAXY 70 stars	001 015	gold-plated	100 W (halogen)	2,560.00
30 tails à 4 m,	001 016	nickel-plated	100 W (halogen)	2,560.00
40 tails à 6 m	001 019	chrome matte	100 W (halogen)	2,560.00
	001 020	white	100 W (halogen)	2,560.00



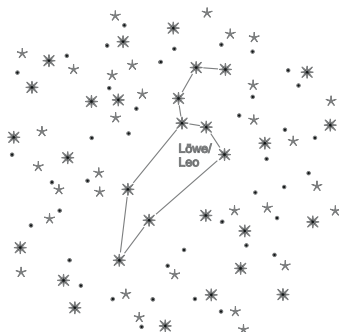

UNIVERSE 100 STARS

Fiber optic lighting system

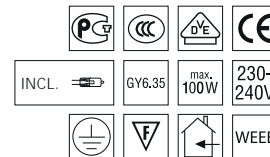

Product	Article number A.9930 NR ...	Version	Light projector	Price EUR
UNIVERSE 100 stars	001 002	gold-plated	100 W (halogen)	3,190.00
40 tails à 3 m,	001 008	nickel-plated	100 W (halogen)	3,190.00
60 tails à 5 m	001 021	chrome matte	100 W (halogen)	3,190.00
	001 022	white	100 W (halogen)	3,190.00

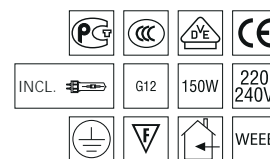

UNIVERSE 100 stars	001 009	gold-plated	150 W (HID)	4,230.00
40 tails à 3 m,	001 010	nickel-plated	150 W (HID)	4,230.00
60 tails à 5 m	001 023	chrome matte	150 W (HID)	4,230.00
	001 024	white	150 W (HID)	4,230.00

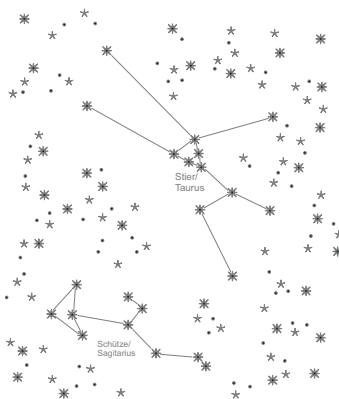

STARDUST 150 STARS

Fiber optic lighting system

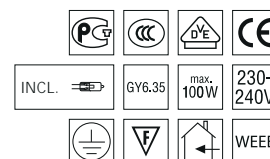

Product	Article number A.9930 NR ...	Version	Light projector	Price EUR
STARDUST 150 stars	001 101	gold-plated	100 W (halogen)	5,210.00
60 tails à 5 m,	001 102	nickel-plated	100 W (halogen)	5,210.00
60 tails à 8 m,	001 109	chrome matte	100 W (halogen)	5,210.00
30 tails à 10 m	001 110	white	100 W (halogen)	5,210.00

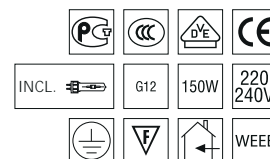

STARDUST 150 stars	001 103	gold-plated	150 W (HID)	6,020.00
60 tails à 5 m,	001 104	nickel-plated	150 W (HID)	6,020.00
60 tails à 8 m,	001 111	chrome matte	150 W (HID)	6,020.00
30 tails à 10 m	001 112	white	150 W (HID)	6,020.00



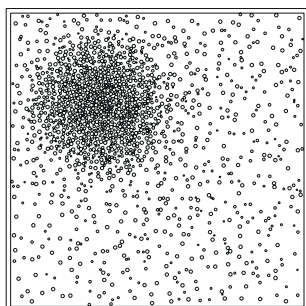

IMPLOSION FOL

Ceiling panel, configured for fiber optic

Product	Article number A.9938 NR ...	Version	Price EUR
IMPLOSION 595 x 595 mm	300 059	with depth effect	1,870.00
IMPLOSION 1.000 x 1.000 mm	300 100	with depth effect	4,310.00

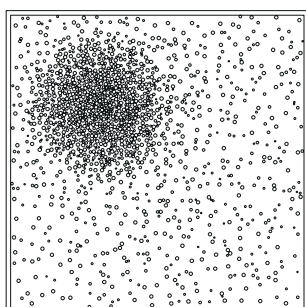

IMPLOSION LED

Ceiling panel, LED-illuminated

Product	Article number A.9932 NR ...	Version	Price EUR
IMPLOSION 595 x 595 mm	700 059	with depth effect	2,980.00
IMPLOSION 1.000 x 1.000 mm	700 100	with depth effect	6,790.00

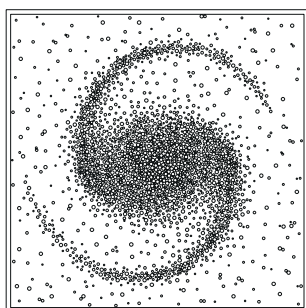
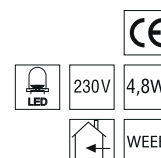

ANDROMEDA FOL

Ceiling panel, configured for fiber optic

Product	Article number A.9938 NR ...	Version	Price EUR
ANDROMEDA 595 x 595 mm	400 059	with depth effect	2,060.00
ANDROMEDA 1.000 x 1.000 mm	400 100	with depth effect	4,760.00

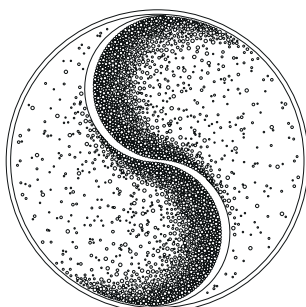

NORTHERN LIGHTS FOL

Ceiling panel, configured for fiber optic

Product	Article number A.9938 NR ...	Version	Price EUR
NORTHERN LIGHT Ø 1.000 mm	520 100	with depth effect	7,400.00
NORTHERN LIGHT Ø 1.500 mm	520 150	with depth effect	13,900.00



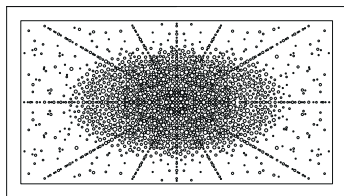

SUPERNOVA LED

Wall panel, LED-illuminated

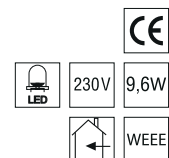

Product	Article number A.9932 NR ...	Version	Price EUR
SUPERNOVA 960 x 540 mm, LED-illuminated	800 100	with depth effect	5,250.00

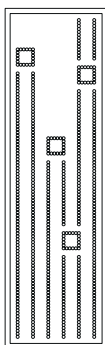

ORNAMENTIC 1

Wall panel, non-illuminated

Product	Article number A.9938 NR ...	Version	Price EUR
ORNAMENTIC 1 300 x 1.000 mm, non-illuminated	100 100	decorative wall element	1,460.00

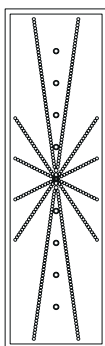

ORNAMENTIC 2 LED

Wall panel, LED-illuminated

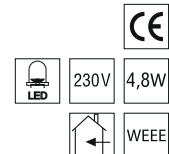

Product	Article number A.9932 NR ...	Version	Price EUR
ORNAMENTIC 2 300 x 1.000 mm, LED-illuminated	900 100	wall element with soft depth effect	1,820.00



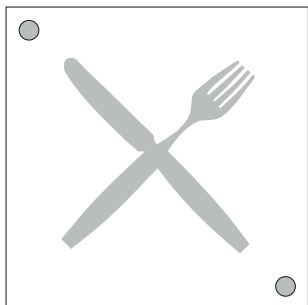

RESTAURANT

Wall panel, non-illuminated

Product	Article number A.9938 NR ...	Version	Price EUR
RESTAURANT 200 x 200 mm	000 016	2 diagonal bore holes and 2 special steel holding devices	200.00

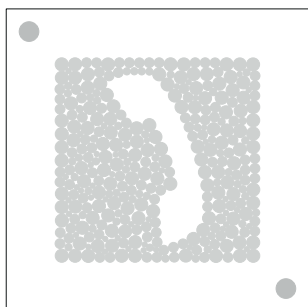

TELEPHONE

Wall panel, non-illuminated

Product	Article number A.9938 NR ...	Version	Price EUR
TELEPHONE 200 x 200 mm	000 017	2 diagonal bore holes and 2 special steel holding devices	200.00

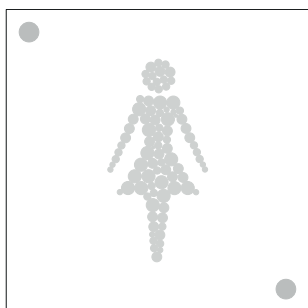

LADIE'S ROOM

Wall panel, non-illuminated

Product	Article number A.9938 NR ...	Version	Price EUR
LADIE'S ROOM 200 x 200 mm	000 018	2 diagonal bore holes and 2 special steel holding devices	200.00



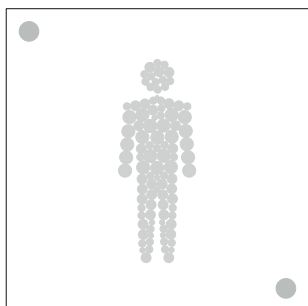

MEN'S ROOM

Wall panel, non-illuminated

Product	Article number A.9938 NR ...	Version	Price EUR
MEN'S ROOM 200 x 200 mm	000 019	2 diagonal bore holes and 2 special steel holding devices	200.00

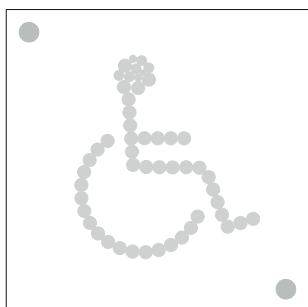

HANDICAPPED RESTROOM

Wall panel, non-illuminated

Product	Article number A.9938 NR ...	Version	Price EUR
HANDICAPPED RESTROOM 200 x 200 mm	000 020	2 diagonal bore holes and 2 special steel holding devices	200.00



BAR

Wall panel, non-illuminated

Product	Article number A.9938 NR ...	Version	Price EUR
BAR 300 x 200 mm	000 144	4 diagonal bore holes and 4 special steel holding devices	221.00





ROOM

Wall panel, non-illuminated

Product	Article number A.9938 NR ...	Version	Price EUR
ROOM 300 x 200 mm	000 145	4 diagonal bore holes and 4 special steel holding devices	221.00



SUITE

Wall panel, non-illuminated

Product	Article number A.9938 NR ...	Version	Price EUR
SUITE 300 x 200 mm	000 146	4 diagonal bore holes and 4 special steel holding devices	221.00



RESTAURANT

Wall panel, non-illuminated

Product	Article number A.9938 NR ...	Version	Price EUR
RESTAURANT 300 x 200 mm	000 147	4 diagonal bore holes and 4 special steel holding devices	221.00





RECEPTION

Wall panel, non-illuminated

Product	Article number A.9938 NR ...	Version	Price EUR
RECEPTION 300 x 200 mm	000 066	4 diagonal bore holes and 4 special steel holding devices	221.00



CAFÉ

Wall panel, non-illuminated

Product	Article number A.9938 NR ...	Version	Price EUR
CAFÉ 300 x 200 mm	000 067	4 diagonal bore holes and 4 special steel holding devices	221.00



ACCESSORIES Luminaires

Product	Description	Article number A.9950 NR ...	Suitable for...	Price EUR
Halogen low voltage	35W, 12V, pin base GY6.35	502 600	SINAR 100 mm, MADISON (recessed ceiling luminaire), DOWNSQUARE, SUPREME, MOVE, BOOGIE, FELLOW, SPOTS, FLAIR	5.46
Halogen low voltage	50W, 12V, pin base GY6.35, energy saver	500 010	MADISON (recessed ceiling luminaire), DOWNSQUARE, SUPREME, MOVE, BOOGIE, FELLOW, SPOTS, FLAIR	8.08
Halogen low voltage	35W, 12V, ø 35 mm, pin base GU4, Coolspot, dispersion angle: 36°	509 603	OCTA 60 mm (surface-mounted pendant luminaire)	10.40
Halogen low voltage	5.5W, 12V, ø 51 mm, base GU5.3, Coolspot, dispersion angle: 36°, light color: warm white	502 602	OCTA 60 mm (recessed ceiling luminaire), URBIC, MADISON 50 mm, ATLAS, VEGA, VAILA, ICE, DECO, 4 REFLEX	9.70
LED	5.5W, 12V, ø 51 mm, base GU5.3, Coolspot, dispersion angle: 36°, light color: warm white	500 014	OCTA 60 mm (recessed ceiling luminaire), URBIC, MADISON 50 mm, ATLAS, VEGA, VAILA, ICE, DECO, 4 REFLEX can also be combined with A.9943 NR 500 012	97.60
Halogen high voltage	25W, 230V, base G9	509 601	MOSAIX, VERVE, EYRIS	9.35
Halogen high voltage	50W, 230V, ø 51 mm, base GU10, Coolspot, dispersion angle: 35°	500 013	MOSAIX 216 mm, MOSAIX 318 mm	11.90
Halogen high voltage	80W, 230V, ø 12 mm, base R7s, length: 74.9 mm, energy saver	509 605	MADISON (surface-mounted wall luminaire)	10.40
Halogen high voltage	50W, 230V, ø 51 mm, base GZ10, Coolspot, dispersion angle: 50°	500 001	ATLAS select	15.10
Halogen high voltage	100W, 230V, base E27	509 607	URNS, RINGLET	31.30
Metal halide lamp (HID)	35W, pin base G8.5, light color: neutral white, HCI-TC 35/942 NDL	500 012	MADISON, DOWNSQUARE	57.60
Metal halide lamp (HID)	35W, pin base G8.5, light color: neutral white, HCI-TC 35/942 NDL	500 011	MADISON, DOWNSQUARE	57.60
Metal halide lamp (HID)	35W, pin base G12, light color: warm white, CDM-T/830	500 005	ELEGANCE, NOBLESSE	61.70
Metal halide lamp (HID)	70W, pin base G12, light color: warm white, CDM-T/830	500 006	ELEGANCE, NOBLESSE	61.70



ACCESSORIES Operating devices

Product	Description	Article number A.9950 NR ...	Suitable for...	Price EUR
Electronic transformer	Power output: 35 – 105VA Output voltage: 11.5V Input voltage: 230 – 240V, 50/60Hz Dimensions: 120 x 42 x 31 mm	500 130	SINAR 100 mm, MADISON (recessed ceiling luminaire), MADISON 50 mm, DOWNSQUARE, SUPREME, MOVE, BOOGIE, FELLOW, SPOTS, FLAIR, OCTA 60 mm (recessed ceiling luminaire), URBIC, ATLAS, VEGA, VAILA, ICE, DECO, 4 REFLEX	34.50
Electronic ballast (HID)	Power output: 35W Input voltage: 220 – 240V, 50/60Hz Dimensions: 160 x 80 x 35 mm	500 003	MADISON, DOWNSQUARE, ELEGANCE, NOBLESSE	100.00
Electronic ballast (HID)	Power output: 70W Input voltage: 220 – 240V, 50/60Hz Dimensions: 180 x 80 x 35 mm	500 007	ELEGANCE, NOBLESSE	100.00

Product	Description	Article number A.9943 NR ...	Suitable for...	Price EUR
Power supply unit (LED)	Power output: max. 5W Output current: 350mA Input voltage: 120 – 240V, 50/60Hz Dimensions: 45 x 45 x 26 mm	000 120	BLOOM	30.40
Power supply unit (LED)	Power output: 0.9 – 20W Output voltage: 24V DC Input voltage: 100 – 240V, 50/60Hz Dimensions: 60 x 60 x 31 mm	500 012	SAMBA, ROCK, TANGO, SWING, JAZZ	60.60
LED RGB IR control unit	Power output: 15W per circuit Output voltage: 24V DC Input voltage: 24V DC Dimensions: 103 x 67 x 30 mm Color choice or control via infrared	000 131	SWING RGB, JAZZ RGB	120.00
IR remote control RGB	Dimensions: 175 x 30 x 20 mm	000 132	Exclusively available in combination with A.9943 NR 000 131 (LED RGB IR control unit)	36.80

ACCESSORIES Miscellaneous

Product	Description	Article number A.9943 NR ...	Suitable for...	Price EUR
Wall bracket for recessed LED luminaires	Depth of insertion: 89 mm Wall thickness: 10 – 15 mm Wall opening: ø 102 mm Application: dry, indoors Exclusively for wall mounting	000 061	SWING, JAZZ	39.90

Luminaires are supplied without lamps. Operative devices are included if listed in the appropriate specification!

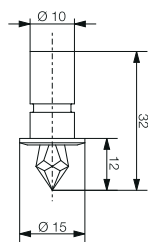

**CRYSTAL 12 mm**

LED-Light fixtures

Product	Article number A.9945 NR ...	Version	Price EUR
Crystal 12 mm	010 400	gold-plated	9.54
	010 402	nickel-plated	9.54

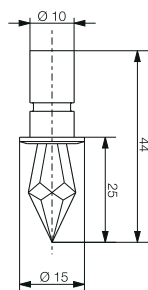
**CRYSTAL 25 mm**

LED-Light fixtures

Product	Article number A.9945 NR ...	Version	Price EUR
Crystal 25 mm	010 500	gold-plated	11.90
	010 502	nickel-plated	11.90

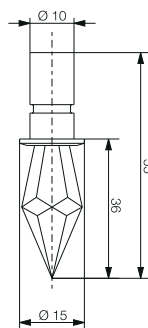
**CRYSTAL 36 mm**

LED-Light fixtures

Product	Article number A.9945 NR ...	Version	Price EUR
Crystal 36 mm	010 600	gold-plated	13.10
	010 602	nickel-plated	13.10

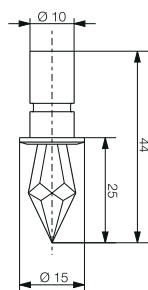
**CRYSTAL 25 mm**

LED-Light fixtures

Product	Article number A.9945 NR ...	Version	Price EUR
Crystal 25 mm, medium sapphire	010 507	gold-plated	14.70
	010 508	nickel-plated	14.70
Crystal 25 mm, rosaline	010 509	gold-plated	14.70
	010 510	nickel-plated	14.70
Crystal 25 mm, antique green	010 503	gold-plated	14.70
	010 504	nickel-plated	14.70
Crystal 25 mm, light topaz	010 505	gold-plated	14.70
	010 506	nickel-plated	14.70

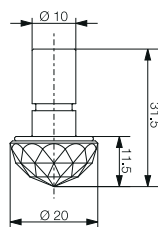
**CRYSTAL Ø 20 mm**

LED-Light fixtures

Product	Article number A.9945 NR ...	Version	Price EUR
Crystal Ø 20 mm	010 850	gold-plated	14.00
	010 852	nickel-plated	14.00



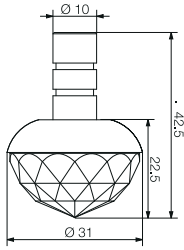

CRYSTAL Ø 31 mm

LED-Light fixtures

Product	Article number A.9945 NR ...	Version	Price EUR
Crystal Ø 31 mm	010 810	nickel-plated	38.30

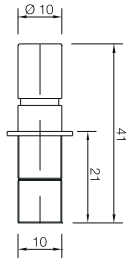

DOUBLE CUBE straight

LED-Light fixtures

Product	Article number A.9945 NR ...	Version	Price EUR
Double Cube straight	015 303	nickel-plated	18.00

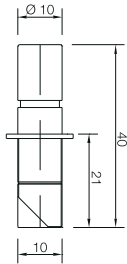

DOUBLE CUBE diagonal

LED-Light fixtures

Product	Article number A.9945 NR ...	Version	Price EUR
Double Cube diagonal	015 403	nickel-plated	21.80

ACCESSORIES, Crystal StarLED

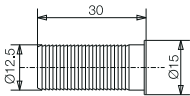

UNIVERSAL-MOUNTING-SLEEVE

Product	Article number A.9945 NR ...	Version	Price EUR
Universal-Mounting-Sleeve 30 mm	019 034	transparent	2.78

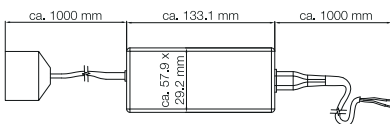

ELECTRONIC POWER SUPPLY UNIT

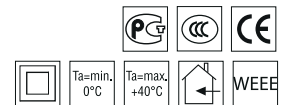

Product	Article number A.9943 NR ...	Version	Price EUR
Electronic Power Supply Unit	000 025	with external plug-in connector block	166.00



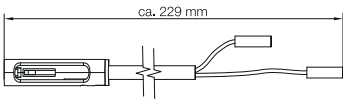
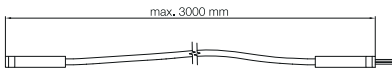
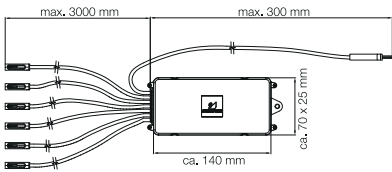

DISTRIBUTOR-MODULE 0.5 W

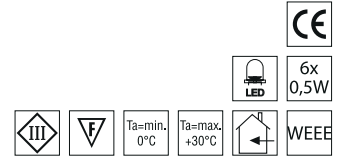

Product	Article number A.9943 NR ...	Light color	Price EUR
Distributor Module 0.5 W	000 026	daylight white (approx. 8.000K)	149.00
	000 027	neutral white (approx. 3.500K)	149.00

EXTENSION CABLE

Product	Article number A.9943 NR ...	Version	Price EUR
Extension Cable 0.5 W	000 028	Length: 3 m	11.50

REPAIR-KIT 0.5 W

Content: 6 LED-Inserts

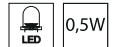

Product	Article number A.9943 NR ...	Light color	Price EUR
Repair-Kit 0.5 W	000 029	daylight white (approx. 8.000K)	94.60
	000 030	neutral white (approx. 3.500K)	94.60

COMPONENTS FOR INDIVIDUAL LIGHTING DESIGN, Crystal StarLED Deluxe

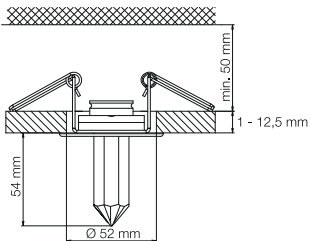

CRYSTAL 8¹⁴ / 8¹⁶ / 12¹² / 12²⁴

LED-Light fixtures

Product	Article number A.9945 NR ...	Version	Price EUR
Crystal 8 ¹⁴	000 031	gold-plated	63.10
	000 032	chrome-plated	63.10
Crystal 8 ¹⁶	000 033	gold-plated	63.10
	000 034	chrome-plated	63.10
Crystal 12 ¹²	000 038	gold-plated	63.10
	000 039	chrome-plated	63.10
Crystal 12 ²⁴	000 040	gold-plated	63.10
	000 041	chrome-plated	63.10



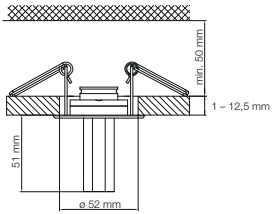

CRYSTAL 8¹ / 12¹

LED-Light fixtures

Product	Article number A.9945 NR ...	Version	Price EUR
Crystal 8¹	000 140	gold-plated	71.90
	000 141	chrome-plated	71.90
Crystal 12¹	000 142	gold-plated	71.90
	000 143	chrome-plated	71.90

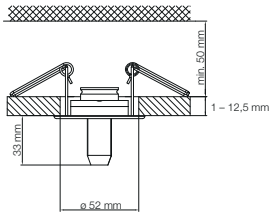

CYRSTAL 4⁵

LED-Light fixtures

Product	Article number A.9945 NR ...	Version	Price EUR
Crystal 4⁵ square	000 144	gold-plated	71.90
	000 145	chrome-plated	71.90
Crystal 4⁵ rhomb	000 146	gold-plated	71.90
	000 147	chrome-plated	71.90

ACCESSORIES, Crystal StarLED Deluxe

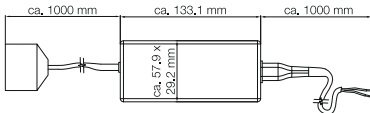

ELECTRONIC POWER SUPPLY UNIT

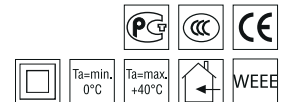

Product	Article number A.9943 NR ...	Version	Price EUR
Electronic Power Supply Unit	000 025	with external plug-in connector block	166.00

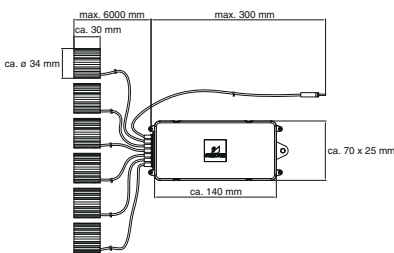

DISTRIBUTOR-MODULE 1 W

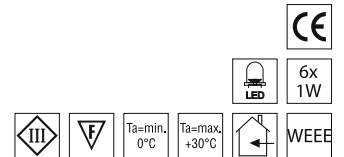

Product	Article number A.9943 NR ...	Light color	Price EUR
Distributor Module 1 W	000 033	daylight white (approx. 6.700K)	264.00
	000 034	neutral white (approx. 3.400K)	264.00

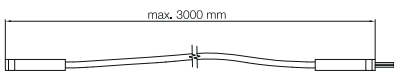

EXTENSION CABLE

Product	Article number A.9943 NR ...	Version	Price EUR
Extension Cable 1 W	000 037	Length: 3 m	26.50

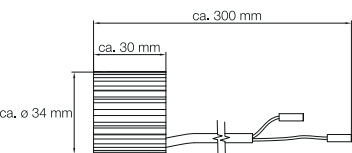

REPAIR-KIT 1 W

Content: 1 LED-Inserts



Product	Article number A.9943 NR ...	Light color	Price EUR
Repair-Kit 1 W	000 035	daylight white (approx. 6.700K)	33.30
	000 036	neutral white (approx. 3.400K)	33.30

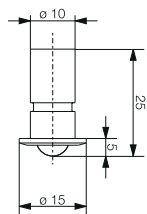

**SPHERICAL LENSE Ø 7,4 mm**

Light fixtures for fiber optic lighting systems

Product	Article number A.9942 NR ...	Version	Price EUR
Spherical lens Ø 7,4 mm	010 300	gold-plated	7.54
	010 302	nickel-plated	7.54
	010 305	chrome mattee	7.54
	010 307	white	7.54

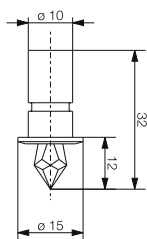
**CRYSTAL 12 mm**

Light fixtures for fiber optic lighting systems

Product	Article number A.9942 NR ...	Version	Price EUR
Crystal 12 mm	010 400	gold-plated	9.54
	010 402	nickel-plated	9.54
	010 400 MC	gold-plated	10.30
	010 402 MC	nickel-plated	10.30
	010 405	chrome mattee	9.54
	010 407	white	9.54
	010 405 MC	chrome mattee	10.30
	010 407 MC	white	10.30

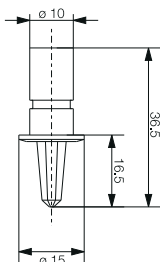
**CRYSTAL 16,5 mm**

Light fixtures for fiber optic lighting systems

Product	Article number A.9942 NR ...	Version	Price EUR
Crystal 16,5 mm	010 900	gold-plated	12.30
	010 902	nickel-plated	12.30
	010 900 MC	gold-plated	13.10
	010 902 MC	nickel-plated	13.10
	010 905	chrome mattee	12.30
	010 907	white	12.30
	010 905 MC	chrome mattee	13.10
	010 907 MC	white	13.10

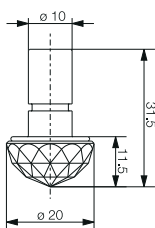
**CRYSTAL Ø 20 mm**

Light fixtures for fiber optic lighting systems

Product	Article number A.9942 NR ...	Version	Price EUR
Crystal Ø 20 mm	010 850	gold-plated	14.00
	010 852	nickel-plated	14.00



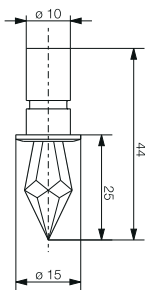

CRYSTAL 25 mm

Light fixtures for fiber optic lighting systems

Product	Article number A.9942 NR ...	Version	Price EUR
Crystal 25 mm	010 500	gold-plated	11.90
	010 502	nickel-plated	11.90

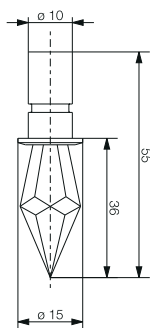

CRYSTAL 36 mm

Light fixtures for fiber optic lighting systems

Product	Article number A.9942 NR ...	Version	Price EUR
Crystal 36 mm	010 600	gold-plated	13.10
	010 602	nickel-plated	13.10

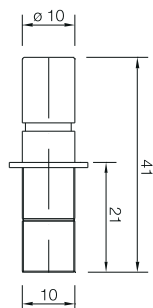

DOUBLE CUBE straight

Light fixtures for fiber optic lighting systems

Product	Article number A.9942 NR ...	Version	Price EUR
Double Cube straight	015 303	nickel-plated	21.50
	015 305	chrome matte	21.50
	015 307	white	21.50

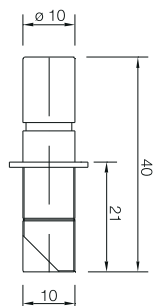

DOUBLE CUBE diagonal

Light fixtures for fiber optic lighting systems

Product	Article number A.9942 NR ...	Version	Price EUR
Double Cube diagonal	015 403	nickel-plated	21.80
	015 405	chrome matte	21.80
	015 407	white	21.80
	015 403 MC	nickel-plated	22.30
	015 405 MC	chrome matte	22.30
	015 407 MC	white	22.30

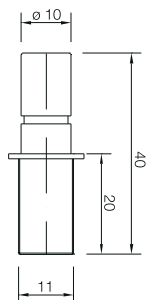

**ASHLAR**

Light fixtures for fiber optic lighting systems

Product	Article number A.9942 NR ...	Version	Price EUR
Ashlar	015 503	nickel-plated	21.50
	015 505	chrome matte	21.50
	015 507	white	21.50

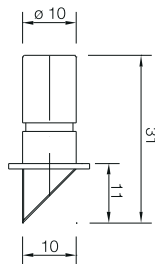
**MINI WALL WASHER**

Light fixtures for fiber optic lighting systems

Product	Article number A.9942 NR ...	Version	Price EUR
Mini Wall Washer	015 603	nickel-plated	26.60
	015 605	chrome matte	26.60
	015 607	white	26.60

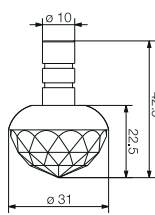
**CRYSTAL Ø 31 mm**

Light fixtures for fiber optic lighting systems

Product	Article number A.9942 NR ...	Version	Price EUR
Crystal Ø 31 mm	010 810	nickel-plated	38.30

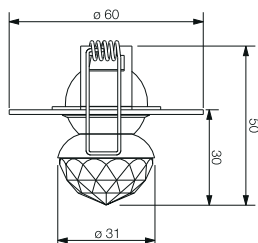
**CRYSTAL SPOT Ø 31 mm**

Light fixtures for fiber optic lighting systems

Product	Article number A.9942 NR ...	Version	Price EUR
Crystal Spot Ø 31 mm	010 820	nickel-plated	77.00

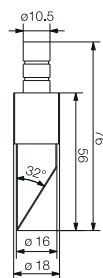
**PRISMA 32°**

Light fixtures for fiber optic lighting systems

Product	Article number A.9942 NR ...	Version	Price EUR
Prisma 32°	011 400	nickel-plated	43.00

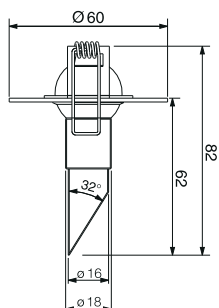
**PRISM SPOT 32°**

Light fixtures for fiber optic lighting systems

Product	Article number A.9942 NR ...	Version	Price EUR
Prism Spot 32°	011 410	nickel-plated	83.70



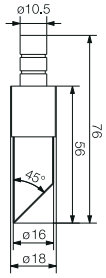

PRISMA 45°

Light fixtures for fiber optic lighting systems

Product	Article number A.9942 NR ...	Version	Price EUR
Prisma 45°	011 300	nickel-plated	43.00

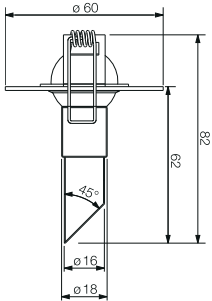

PRISM SPOT 45°

Light fixtures for fiber optic lighting systems

Product	Article number A.9942 NR ...	Version	Price EUR
Prism Spot 45°	011 310	nickel-plated	83.70

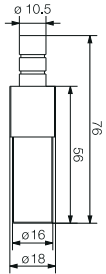

PRISMA 0°

Light fixtures for fiber optic lighting systems

Product	Article number A.9942 NR ...	Version	Price EUR
Prisma 0°	011 200	nickel-plated	38.30

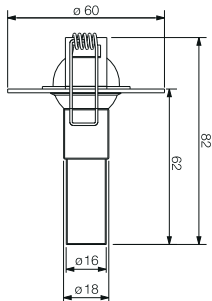

PRISM SPOT 0°

Light fixtures for fiber optic lighting systems

Product	Article number A.9942 NR ...	Version	Price EUR
Prism Spot 0°	011 210	nickel-plated	78.80

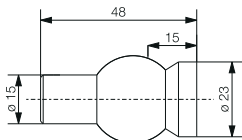

FOCUSING LENS SYSTEM

Light fixtures for fiber optic lighting systems

Product	Article number A.9942 NR ...	Version	Price EUR
Focusing Lens System	030 010	black	51.90
	030 011	white	51.90
	030 012	nickel-plated	51.90



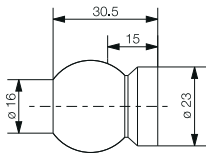

SPHERICAL LENS SYSTEM

Light fixtures for fiber optic lighting systems

Product	Article number A.9942 NR ...	Version	Price EUR
Spherical Lens System	030 110	black	23.70
	030 111	white	23.70
	030 112	nickel-plated	23.70

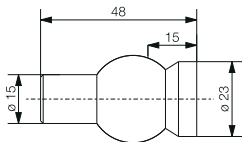

AUXILIARY LENS SYSTEM

Light fixtures for fiber optic lighting systems

Product	Article number A.9942 NR ...	Version	Price EUR
Auxiliary Lens System	030 210	black	51.90
	030 211	white	51.90
	030 212	nickel-plated	51.90

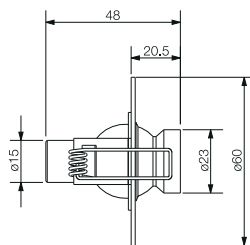

FOCUSING OPTIC SPOT

Light fixtures for fiber optic lighting systems

Product	Article number A.9942 NR ...	Version	Price EUR
Focusing Optic Spot	020 810	white	91.40
	020 811	black	91.40
	020 813	nickel-plated	91.40

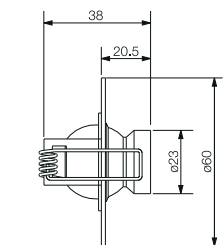

SPHERICAL OPTIC SPOT

Light fixtures for fiber optic lighting systems

Product	Article number A.9942 NR ...	Version	Price EUR
Spherical Optic Spot	020 800	white	62.00
	020 801	black	62.00
	020 803	nickel-plated	62.00

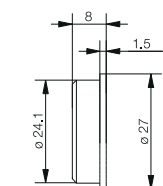

MINI-LENS

Light fixtures for fiber optic lighting systems

Product	Article number A.9942 NR ...	Version	Price EUR
Mini-Lens	020 700	white, mounting ring white	18.50
	020 701	black, mounting ring black	18.50
	020 703	chrome, mounting ring translucent	18.50

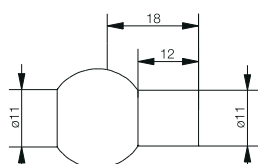

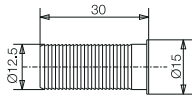

UNIVERSAL MOUNTING SLEEVES

Product	Article number A.9942 NR ...	Version	Price EUR
Universal Mounting Sleeve 30 mm	019 034	transparent plastic	2.78
Universal Mounting Sleeve 85 mm	019 039	white plastic	5.49
Universal Mounting Sleeve 140 mm	019 036	white plastic	5.62
Mounting Sleeve 28.1 mm	019 031	gold-colored plastic	1.24
Mounting Sleeve 27.5 mm	019 030	gold-plated metal	3.95

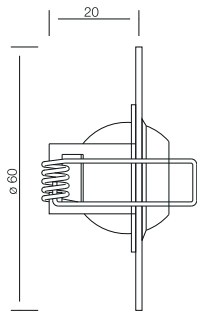

SPHERICAL JOINT

Product	Article number A.9942 NR ...	Version	Price EUR
Spherical Joint	019 041	nickel-plated	39.40

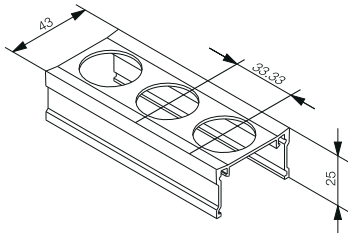

ALUMINIUM RAIL

Product	Article number A.9942 NR ...	Version	Price EUR
Aluminium Rail	030 300	black Holder for focusing-, spherical- and auxiliary lens systems. Max. 30 lenses per running meter.	117.00

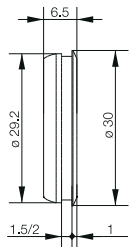

MOUNTING RING

Holder for focusing-, spherical- and auxiliary lens systems.

Product	Article number A.9942 NR ...	Version	Price EUR
Mounting Ring	030 350	Material thickness 1.5 mm, black	4.43
	030 352	Material thickness 1.5 mm, transparent	4.43
	030 354	Material thickness 1.5 mm, white	4.43
	030 351	Material thickness 2.0 mm, black	4.43
	030 353	Material thickness 2.0 mm, transparent	4.43
	030 355	Material thickness 2.0 mm, white	4.43



LIGHT GUIDES

Glass fiber light guide (ex-stock)

Article number A.9942 NR ...	Size	Fiber Ø (mm)	Tails total	Tails single	Tail lenght (mm)	Weight (g)	Price EUR
110 122	$\frac{3}{4}$	Ø 1.0	80		5,000	3,020	1,100.00
115 010	$1\frac{1}{2}$	Ø 1.4	35	20 15	2,000 3,500	1,380	497.00
115 100	$1\frac{1}{2}$	Ø 1.4	60		2,000	1,580	614.00
115 110	$1\frac{1}{2}$	Ø 1.4	60		4,000	2,880	856.00
115 120	$1\frac{1}{2}$	Ø 1.4	70		3,000	2,600	886.00
115 119	$1\frac{1}{2}$	Ø 1.4	70	30 40	4,000 6,000	3,980	1,110.00
115 121	$1\frac{1}{2}$	Ø 1.4	80		3,000	2,740	908.00
115 122	$1\frac{1}{2}$	Ø 1.4	80		5,000	4,400	1,270.00
115 130	$1\frac{1}{2}$	Ø 1.4	100		3,000	3,350	1,120.00
115 150	$1\frac{1}{2}$	Ø 1.4	100	40 60	3,000 5,000	4,600	1,390.00
115 151	$1\frac{1}{2}$	Ø 1.4	100		8,000	8,550	2,210.00
115 140	$1\frac{1}{2}$	Ø 1.4	150		5,000	8,000	2,230.00
115 141	$1\frac{1}{2}$	Ø 1.4	150	60 60 30	5,000 8,000 10,000	11,150	2,830.00
120 110	3	Ø 2.0	80		3,000	5,600	1,290.00
130 100	8	Ø 3.0	40		2,000	3,260	1,380.00
140 091	14	Ø 4.0 fine randomized fibers	12		1,500	1,520	868.00
140 092	14	Ø 4.0 fine randomized fibers	12	6 6	3,500 6,000	3,720	1,330.00
140 100	14	Ø 4.0	20		1,200	1,920	901.00
140 104	14	Ø 4.0 fine randomized fibers	20	8 12	2,500 4,000	4,450	1,760.00
140 112	14	Ø 4.0 fine randomized fibers	24		2,000	3,450	1,580.00
140 130	14	Ø 4.0 fine randomized fibers	32	15 17	2,500 4,000	6,850	2,230.00
140 120	14	Ø 4.0 fine randomized fibers	33	20 13	2,000 3,000	5,850	1,930.00
140 121 with B4 end ferrules - only for mini-lenses	14	Ø 4.0 fine randomized fibers	33	20 13	2,000 3,000	5,100	1,930.00
140 140 with B4 end ferrules - only for mini-lenses	14	Ø 4.0 fine randomized fibers	32	15 17	3,000 5,000	8,200	2,650.00



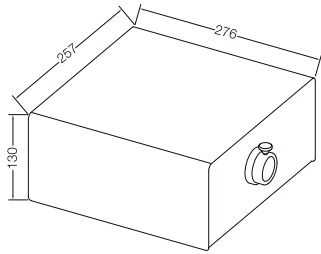

HIGH-LUX 100 W HALOGEN

Light projector

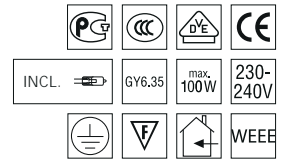

Product	Article number A.9943 NR ...	Version	Price EUR
High-Lux 100 W Halogen	500 100	with integrated electronic transformer	683.00

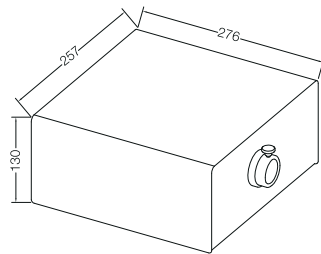

HIGH-LUX 70 W HID

Light projector

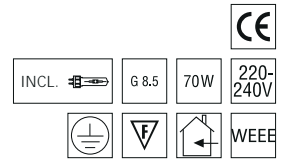

Product	Article number A.9943 NR ...	Version	Price EUR
High-Lux 70 W HID	500 070	with integrated electronic lamp ballast	1,160.00

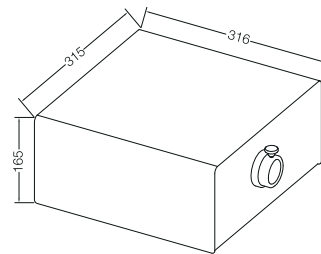

HIGH-LUX 150 W HID

Light projector

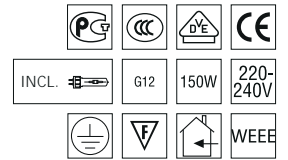

Product	Article number A.9943 NR ...	Version	Price EUR
High-Lux 150 W HID	500 150	with integrated electronic lamp ballast	1,730.00

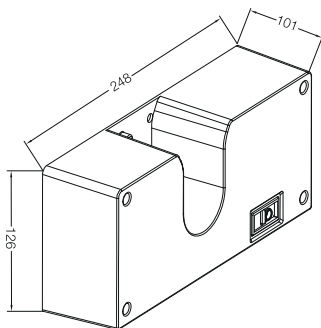

COLOR AND EFFECT MODULE FOR HIGH-LUX LIGHT PROJECTORS



Product	Article number A.9943 NR ...	Version	Price EUR
Color Module	500 001	8 colors, continuous color change	468.00
Effect Module	500 004	flicker effect	455.00



LAMPS

Product	Article number A.9942 NR ...	Version	Price EUR
Lamp for High-Lux 100 W Halogen	059 112	100 W, 12 V, GY6.35	11.00
Lamp for High-Lux 150 W HID	059 113	BLV HID 150 W, 4,200K, G12	68.90
	059 114	BLV HID 150 W, 3,000K, G12	68.90
	A.9943 NR ...		
Lamp for High-Lux 70 W HID	500 003	CDM TC 70 W, 3,000K, G8.5	83.70
Lamp for High-Lux 150 W HID	000 015	CDM SA/T 150 W, 4,200K, G12	202.00

CONNECTION CABLE FOR HIGH-LUX LIGHT PROJECTORS

Product	Article number A.9943 NR ...	Version	Price EUR
Connection Cable EU	000 503	Length: 2 m	8.65
Connection Cable UK	000 507	Length: 2 m	16.20
Connection Cable CH	000 506	Length: 2 m	16.20





The CE certification mark ("Certified Europe" or "Communauté Européenne") is proof of conformity with the "fundamental specifications" of relevant European standards.



For electronic items including products covered by the German devices and product safety law (GPSG). The VDE mark denotes conformity with the VDE specifications or European or internationally harmonized standards and confirms compliance with the safety requirements of the appropriate directives. The VDE mark denotes the safety of the product in respect of electrical, mechanical, thermal, toxic, radiological and other risks.



ENEC (European Norms Electrical Certification) European is a common certification mark for lamps and electrical components as provided for under the LUM agreement. It indicates norm conformity on products marked with European safety standards, in particular EN60598.



Low voltage halogen lamp



Low voltage halogen reflector lamp with cold-light mirror coating



High voltage halogen reflector lamp with cold-light mirror coating



Metal halide lamp



LED lamp



Protection class I light fixture: connection of PE conductor required



Lamps, Class II protection: Due to appropriate insulation, the lamp has no tangible metal elements, which could lead to accidental electric shock. Not fitted with protective conductor.



Protection class III light fixture: operation with safety extra-low voltage (SELV), creating a safety isolating transformer according to EN 61558-2-6.



Connection voltage



Gost R: Certification of goods for export to the Russian Confederation relates to compliance with stipulations passed which guarantee safety to life, health and property of the consumer as well as environmental protection in Russia.



The CCC text mark (CCC = China Compulsory Certification) is a compulsory test mark indicating the safety and quality of products sold on the Chinese market.



Unless otherwise stated, all luminaires and lighting systems comply with safety class IP20 (protected against solid foreign bodies larger than 12 mm, no protection against water and moisture).



Luminaire complies with safety class IP67 (dust tight, protection against temporary immersion in water)



Light fixtures with this mark are only suitable for direct contact with non-combustible surfaces.



Light fixtures with this mark can be mounted directly to normal flame resistant building materials without additional provisions.



Light fixtures with this mark can be mounted in or on normally-flammable surfaces with the use of heat insulation material.



Low-pressure lamp – suitable for use on lights without a protective cover.



max. power



Minimum distance to the lit object: 0.5 m



Minimum/maximum ambient temperature



Installation only in dry rooms



CONSUMER NOTICE: This Swarovski product is subject to Directive 2002/96/EC of the European Parliament and the Council of the European Union on waste electrical and electronic equipment (WEEE) and is put on the market after August 13, 2005, and should not be disposed of as unsorted municipal waste. Please utilize your local WEEE collection facilities when disposing of this product and otherwise observe all applicable legal requirements.



The luminaires/lighting systems in this catalogue are designed and manufactured in compliance with the specifications of EN 60598/VDE 0711. The largest part of the luminaires/lighting systems bears a corresponding test mark on the rating plate and on packaging and instructions for use. The other luminaires/lighting systems have been submitted for testing. The testing and approval procedure has not however yet been completed. Information on the current progress of approval marking can be obtained from us at any time.



NORTH- AND SOUTH AMERICA

Swarovski Lighting, Inc.
 c/o Schonbek Worldwide Lighting, Inc.
 61 Industrial Boulevard
 Plattsburgh, New York 12901-1908
 USA
 Local Phone +1 / 518 / 324 4233
 Fax. +1 / 518 / 324 6730
swarovski.lighting@schonbek.com

EUROPE

Swarovski Aktiengesellschaft
 Dröschstrasse 15
 P.O. Box 567
 9495 Triesen
 Principality of Liechtenstein
 Tel. +423 / 399 / 5656
 Fax. +423 / 399 / 6666
lighting.europe@swarovski.com

GERMANY
 Tel. +800 / 42 / 22000
 Fax. +423 / 399 / 6666

AUSTRIA
 Tel. +43 / 5224 / 500 5656
 Tel. +43 / 5224 / 500 5666

FRANCE
 Tel. +33 / 1 / 44 76 15 53
 Fax. +33 / 1 / 44 76 15 54

GREAT BRITAIN
 Tel. +44 / 845 / 607 0341
 Fax. +44 / 845 / 607 0342

AFRICA / NEAR EAST / ASIA / PAZIFIC

Swarovski Middle East FZE
 P.O. Box 17128
 Jebel Ali Free Zone R/A 6
 Dubai
 UAE
 Tel. +971 / 4 / 881 65 62
 Fax. +971 / 4 / 881 56 23
lighting.me@swarovski.com

You can find worldwide sales companies and sales representatives here: ARCHITECTURE.SWAROVSKI.COM/SALESCOMPANIES

© 2011 Swarovski AG

All rights reserved. The publication, transfer, or any other form of copying contents or parts thereof, in any form, is forbidden, unless previously agreed in writing by Swarovski. We reserve the right to change prices and technical details. We will not be held responsible for errors in printing or terminology. Swarovski's sales office general terms and conditions apply. With the issuing of this price list, all previous prices cease to apply. We will be happy to provide information on the country-specific availability of the items described upon request. All measurements given in mm.

The currently valid General Terms and Conditions of Swarovski AG can be found on our homepage ARCHITECTURE.SWAROVSKI.COM/TC.







