



20 KNOBS, *handles* & CO

Knobs, Handles & Co are loose crystal elements as well as semi-finished products. They are ideal for use in the interior segment, for example for bathroom applications or furniture. The articles offered are divided into four categories: Centerparts, Balls, Lever Handles and Semi-finished articles. All of these products come in a large variety of shapes and can be easily applied by gluing and/or screwing.



Summary

<<<

1	2	3		1	2	3	
			7100 20, 30, 40, 50, 60 mm				7301 56 mm
			7110 20, 25, 30, 40, 50 mm				7302 56 mm
			7120 14, 20, 30, 40, 50 mm				7303 60 mm
			7125 20, 30, 40, 50 mm				7304 20 mm
			7130 30, 50 mm				7305 20 mm
			7150 34 mm				7306 40, 60 mm
			7151 62 mm				7307 61 mm
			7155 30 mm				7311 25 mm
			7156 40 mm				7312 50 mm
			7157 50 mm				7314 50 mm
			7160 300 mm				7315 30 mm
			7165 14 mm				7322 50 mm
			7170 110 mm				7323 48 mm
			7300 16 mm				

1 Top View/Threaded View 2 Side View/Hole View 3 Back View

• The logo position is marked with a red dot.
Integrated articles of the former Bath & Wellness Collection may be partly delivered without a laser-engraved logo.

7100 Ball

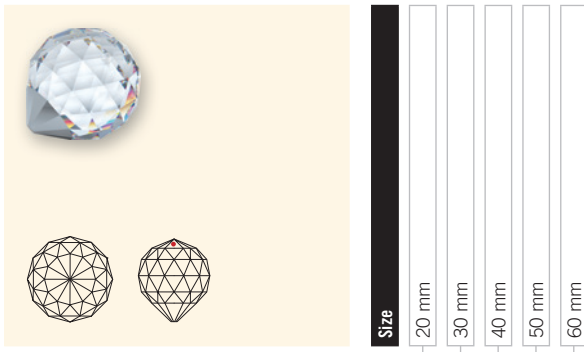

Size

- 20 mm
- 30 mm
- 40 mm
- 50 mm
- 60 mm

Colour

- Crystal CAL VZ SI (001 CAL VZ SI)

7110 3/4 Ball

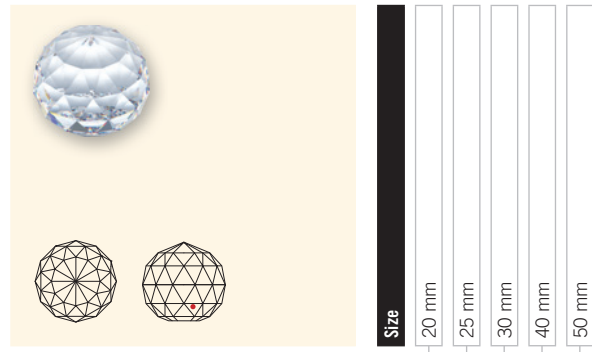

Size

- 20 mm
- 25 mm
- 30 mm
- 40 mm
- 50 mm

Colour

- Crystal CAL VZ SI (001 CAL VZ SI)

7120 Half Ball Classic Cut

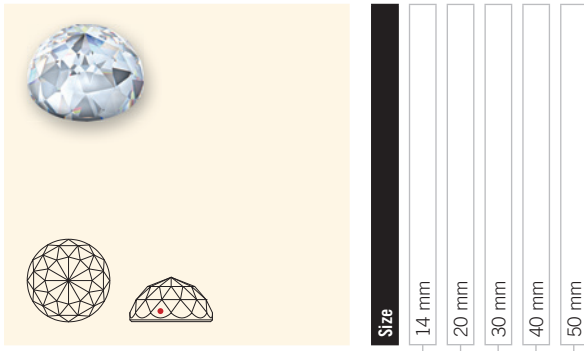

Size

- 14 mm
- 20 mm
- 30 mm
- 40 mm
- 50 mm

Colour

- Crystal (001 CAL SI)
- Crystal CAL V SI (001 CAL V SI)
- Jet (280)

7125 Half Ball Contemporary Cut

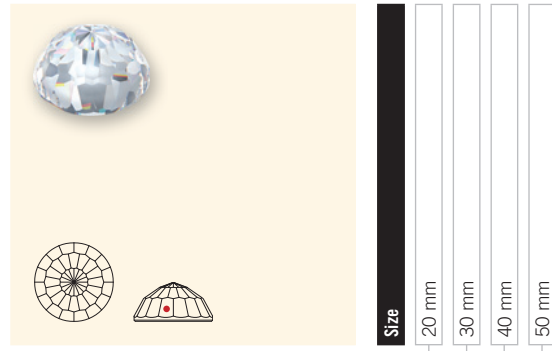

Size

- 20 mm
- 30 mm
- 40 mm
- 50 mm

Colour

- Crystal CAL V SI (001 CAL V SI)

7130 Half Ball With Hole

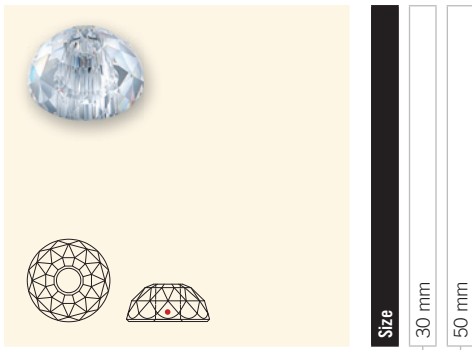

Size

- 30 mm
- 50 mm

Colour

- Crystal CAL V SI (001 CAL V SI)

• The logo position is marked with a red dot.
Integrated articles of the former Bath & Wellness Collection may be partly delivered without a laser-engraved logo.

7150 Chaton Handle



MM 34 mm	
M 5 PCS	30%

7150
7151

Size	34 mm	62 mm	Colour of Casing	081 Gold	082 Silver	088 Stainless Steel
Colour	Crystal CAL V SI (001 CAL V SI)					

7151 Chaton Handle



MM 62 mm	
M 5 PCS	30%

• The logo position is marked with a red dot.
Integrated articles of the former Bath & Wellness Collection may be partly delivered without a laser-engraved logo.



7155 Globe Handle

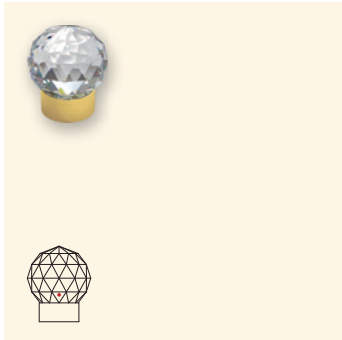

MM 30 mm	
M 5 PCS	35%

7155 7156 7157	Size	30 mm	40 mm	50 mm	Colour of Casing	081 Gold	082 Silver	088 Stainless Steel
	Colour	Crystal CAL VZ SI (001 CAL VZ SI)						

7156 Globe Handle

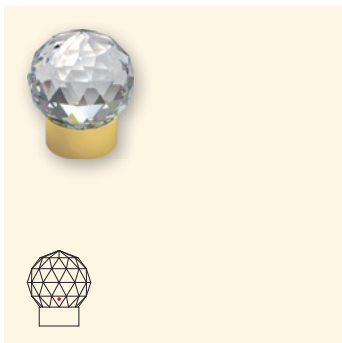

MM 40 mm	
M 5 PCS	35%

7157 Globe Handle



MM 50 mm	
M 5 PCS	35%

• The logo position is marked with a red dot.
Integrated articles of the former Bath & Wellness Collection may be partly delivered without a laser-engraved logo.

7160 Tube Handle

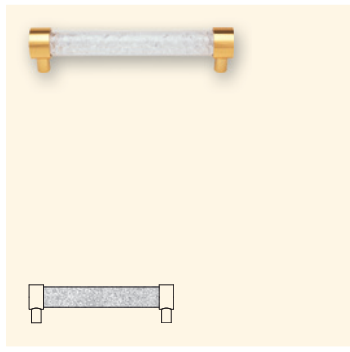

Size	300 mm
Colour of Casing	081 Gold 082 Silver
Colour	Crystal (001)

7165 Inlay

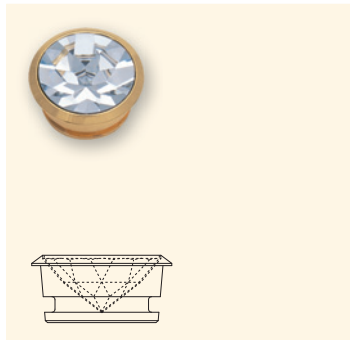

Size	14 mm
Colour of Casing	081 Gold 082 Silver 084 Bronze brushed 085 Silver matt
Colour	Crystal CAL V SI (001 CAL V SI)

7170 Insert

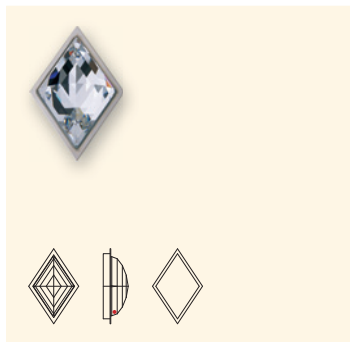

Size	110 mm
Colour of Casing	082 Silver
Colour	Crystal CAL VZ SI (001 CAL VZ SI)

• The logo position is marked with a red dot.
Integrated articles of the former Bath & Wellness Collection may be partly delivered without a laser-engraved logo.

7300 Pin

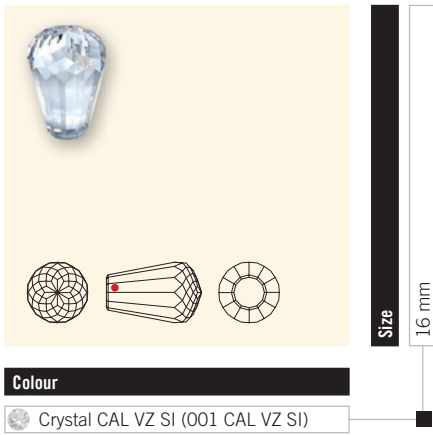

7301 Classic Lever Handle

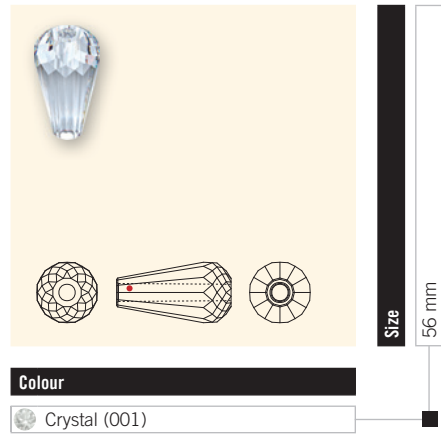

7302 Spiral

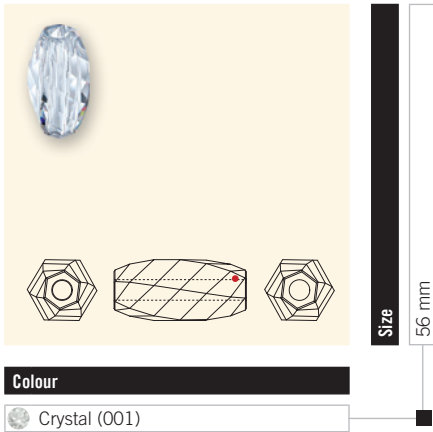

7303 Spectrum

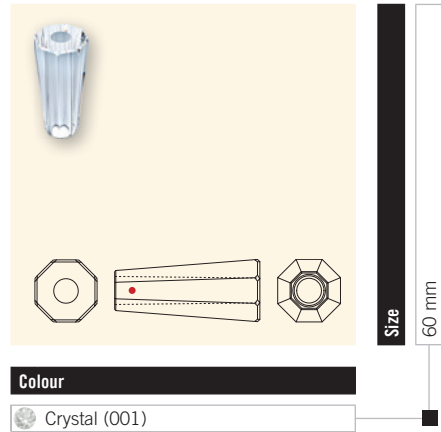

7304 Flame

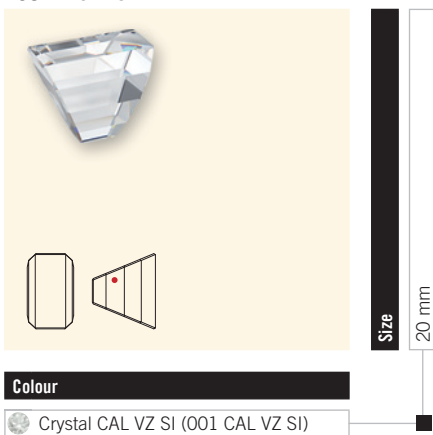

7305 Round Lever Handle

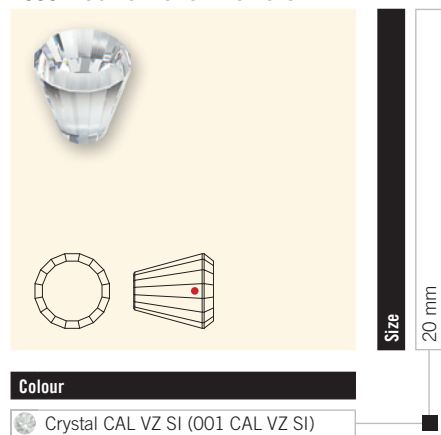

• The logo position is marked with a red dot.
 Integrated articles of the former Bath & Wellness Collection may be partly delivered without a laser-engraved logo.

7306 Sphere Handle

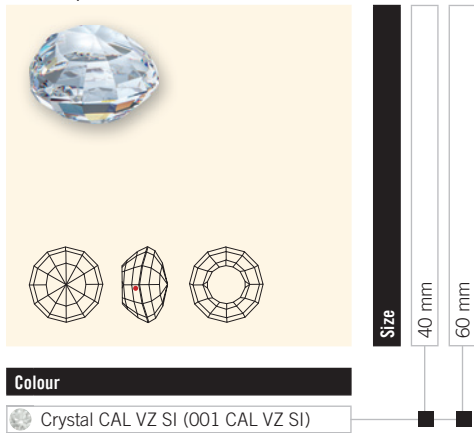

7307 Radiance Handle

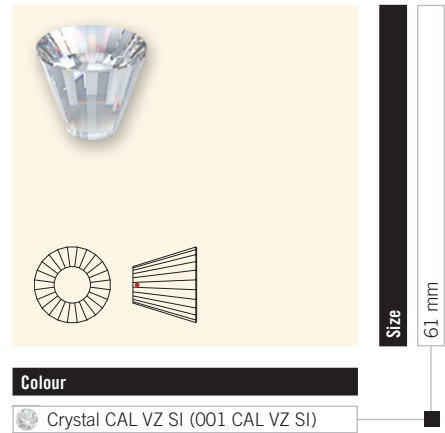

7311 Stick

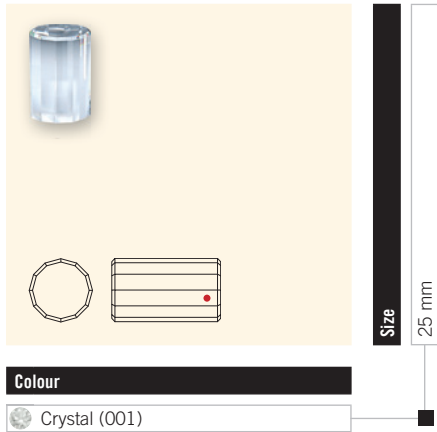

• The logo position is marked with a red dot.
Integrated articles of the former Bath & Wellness Collection may be partly delivered without a laser-engraved logo.



7312 Round Centerpart

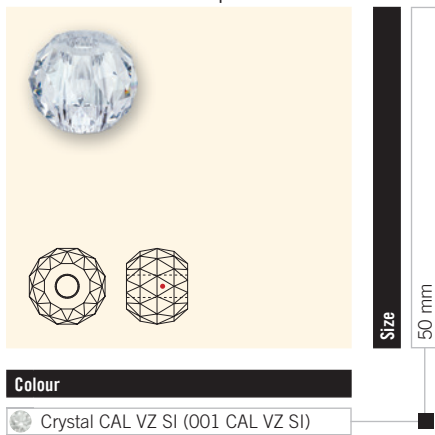

7314 Round Centerpart anti-twist device

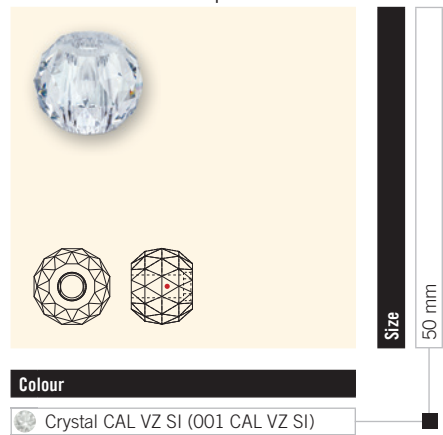

7315 Centerpart blind hole



7322 Ring Centerpart small hole

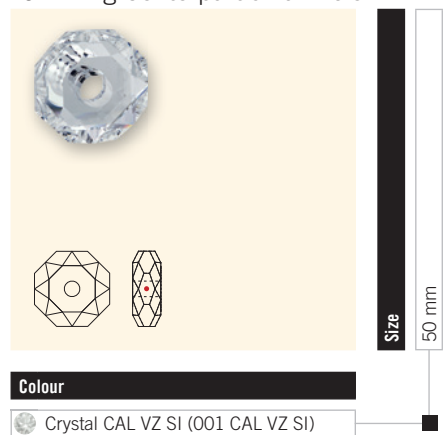

7323 Ring Centerpart big hole

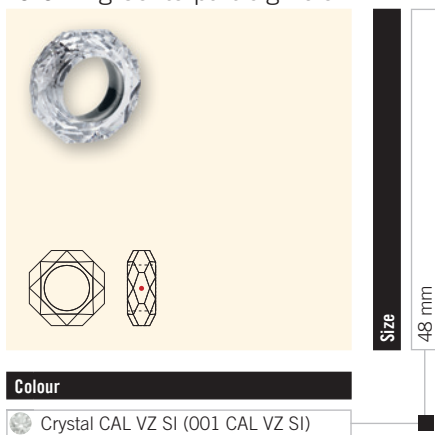

• The logo position is marked with a red dot.
 Integrated articles of the former Bath & Wellness Collection may be partly delivered without a laser-engraved logo.

Product Details

<<<

Article Size	Packing Unit = Minimum Order Quantity in Pieces	Average Net Weight in Gram per Packing Unit Crystal (001)	Average Gross Weight in Gram per Packing Unit Crystal (001)
7100			
20 mm	144	1,609.1	2,023.2
30 mm	48	1,774.3	2,281.5
40 mm	40	3,696.5	4,026.5
50 mm	12	1,954.9	2,236.9
60 mm	5	1,280.5	1,700.2
7110			
20 mm	144	1,486.8	1,943.1
25 mm	144	2,467.4	2,747.1
30 mm	48	1,521.9	1,876.8
40 mm	40	3,253.1	3,480.1
50 mm	12	1,924.3	2,254.6
7120			
14 mm	560	997.0	1,452.0
20 mm	300	1,615.1	2,057.1
30 mm	120	2,140.7	1,962.8
40 mm	60	2,669.0	3,111.0
50 mm	24	1,943.2	2,247.2
7125			
20 mm	300	1,482.8	1,858.8
30 mm	120	1,912.7	2,275.7
40 mm	60	2,553.7	2,889.7
50 mm	24	1,721.4	2,017.3
7130			
30 mm	120	1,817.1	2,180.2
50 mm	24	1,711.3	1,997.3
7150			
34 mm	5	370.5	765.5
7151			
62 mm	5	1,891.8	2,286.8
7155			
30 mm	5	281.1	676.1
7156			
40 mm	5	692.0	1,087.0
7157			
50 mm	5	1,245.5	1,640.5
7160			
300 mm	1	950.0	1,050.0
7165			
14 mm	24	93.4	110.7
7170			
110 mm	1	245.8	285.8
7300			
16 mm	192	1,627.8	2,001.8
7301			
56 mm	30	1,475.2	1,753.2
7302			
56 mm	45	2,447.8	2,684.8
7303			
60 mm	30	1,350.6	1,684.6

Knobs, Handles & Co

Article Size	Packing Unit = Minimum Order Quantity in Pieces	Average Net Weight in Gram per Packing Unit Crystal (001)	Average Gross Weight in Gram per Packing Unit Crystal (001)
7304 20 mm	240	1,648.2	2,138.8
7305 20 mm	150	1,653.3	2,021.3
7306 40 mm 60 mm	40 10	1,889.0 1,614.3	2,273.0 1,922.3
7307 61 mm	5	1,189.5	1,471.5
7311 25 mm	240	2,563.8	3,005.8
7312 50 mm	12	1,651.2	2,013.6
7314 50 mm	12	1,651.3	2,013.6
7315 30 mm	96	1,894.7	2,529.9
7322 50 mm	36	2,951.4	3,150.3
7323 48 mm	36	1,736.7	2,088.3