



## 07 *fancy* STONES & settings

Fancy Stones are offered in numerous shapes ranging from classical gemstone inspired cuts to progressive trend cuts. They come in a huge assortment of different sizes and colours. Showing either a faceted or flat reverse side, Fancy Stones can be glued into pre-cast cavities or used in metal settings. Their precision cut facets assure the highest brilliance and endow design ideas with a unique sparkle.

Settings are unplated brass components, each specifically tailored to a Fancy Stone, that secure the crystal and allow for a myriad of application possibilities including but not limited to sewing, soldering and gluing. Additionally settings can be plated and are easy to work with.







# Fancy Stones & Settings

## Summary

<<<

1	2	3	S		1	2	3	S		1	2	3	S	
				<b>4120</b> 6x4, 8x6, <u>14x10</u> , <u>18x13</u> , 25x18 mm					<b>4470</b> <u>10</u> , <u>12</u> , 18 mm					<b>4737</b> 14, 20, 30 mm
				<b>4127</b> <u>30x22</u> , 39x28 mm				*	<b>4500</b> 3x2, 6x2, 10x3 mm				*	<b>4739</b> 14x11, 20x16 mm
				<b>4128**</b> 6x4, 8x6, 10x8, <u>14x10</u> mm					<b>4501</b> 4x2, 5x2, 5x2.5, <u>7x3</u> , 10x5 mm				*	<b>4744</b> 6, 10 mm
				<b>4137</b> 15x11, 22x16, 33x24 mm					<b>4502</b> 3x1 mm				*	<b>4745</b> 5, 10 mm
				<b>4139</b> 14, 20, 30 mm					<b>4527</b> <u>8x6</u> , <u>14x10</u> , 18x13 mm				*	<b>4756</b> 19x11.5, 27x16, 39x23.5 mm
				<b>4161</b> <u>15x5</u> , <u>21x7</u> , <u>27x9</u> mm					<b>4547</b> <u>15x5</u> , <u>21x7</u> , <u>24x8</u> , <u>30x10</u> mm				*	<b>4757</b> 14x8.5, 19x11.5 mm
			*	<b>4200</b> 11x3, 15x4 mm				*	<b>4565</b> 14x10, 18x13 mm				*	<b>4759</b> 28x24, 38x33 mm
				<b>4227</b> <u>32x17</u> mm				*	<b>4581</b> 24x16 mm					<b>4760</b> <u>14x8</u> , <u>18x10.5</u> , <u>22x12.5</u> mm
			*	<b>4228</b> 4x2, 5x2.5, 6x3, 8x4, 10x5, 15x7 mm				*	<b>4582</b> 24x16 mm					<b>4787</b> 19x13, 27x19 mm
				<b>4320</b> 6x4, 8x6, 10x7, 14x10, <u>18x13</u> mm				*	<b>4583</b> 24x16 mm					<b>4790</b> <u>18x7.5</u> , <u>23x10</u> , <u>32x13.5</u> mm
				<b>4327</b> <u>30x20</u> , 40x27 mm				*	<b>4584</b> 24x16 mm				*	<b>4800</b> 5.5x5, 6.6x6, 8.8x8, 11x10, 15.4x14 mm
			*	<b>4328</b> 6x3.6, 8x4.8, 10x6, 13x7.8 mm				*	<b>4600</b> 6x4, 8x6, 10x8, 12x10 mm					<b>4827</b> <u>28</u> mm
				<b>4335</b> 3.5 mm					<b>4610</b> <u>14x10</u> , <u>18x13</u> , 20x15 mm				*	<b>4831</b> 5.5x5, 8.8x8, 11x10 mm
			*	<b>4370</b> 11x10, 15.5x14, 20x18 mm					<b>4627</b> <u>27x18.5</u> , 37x25.5 mm					<b>4835</b> 3.5 mm
				<b>4428</b> 2, 3, 4, 5, <u>6</u> , 8 mm				*	<b>4675</b> 23 mm					<b>4841</b> 4, 6, 8 mm
				<b>4437</b> 14, 20, 30 mm				*	<b>4704</b> 5 mm					<b>4842</b> 4, 6 mm
				<b>4439</b> 14, 20, 30 mm				*	<b>4722</b> 4, 6, 8, 10 mm					<b>4854</b> 6, 8, 10 mm
				<b>4447</b> <u>6</u> , <u>8</u> , <u>10</u> , <u>12</u> mm					<b>4727</b> 23 mm					<b>4869</b> 4, 6, 8, 10, 12, 14 mm
				<b>4461</b> 8, <u>12</u> , <u>16</u> mm					<b>4735</b> 3.5 mm					

1 Top View 2 Side View 3 Back View S Setting

\* More settings planned for these shapes

\*\* Available as of September 2010! Until September 2010 art. 4100 is still available (please refer to former Collection for product details).

— ... Setting available

Fancy Stones & Settings





# Fancy Stones & Settings

4120

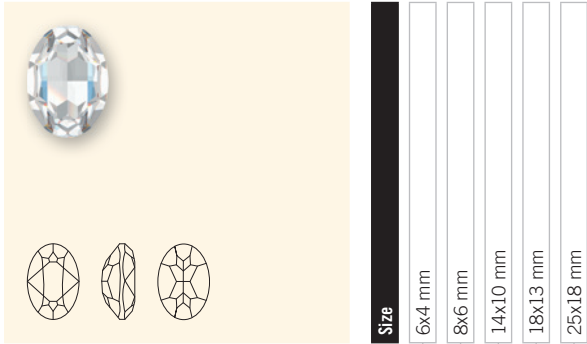

Colour	6x4 mm	8x6 mm	14x10 mm	18x13 mm	25x18 mm
Crystal F (001)	■	■	■	■	■
Crystal Golden Shadow F (001 GSHA)	■	■	■	■	New!
Crystal Metallic Light Gold F (001 MLGLD)	■	■	■	■	
Crystal Moonlight F (001 MOL)	■	■	■	■	New!
Crystal Silver Shade F (001 SSHA)	■	■	■	■	New!
Jet (280)	■	■	■	■	■
Air Blue Opal F (285)	■	■	■	■	
Amethyst F (204)	■	■	■	■	New!
Aquamarine F (202)	■	■	■	■	New!
Black Diamond F (215)	■	■	■	■	New!
Burgundy F (515)	■	■	New!	■	New!
Chrysolite F (238)	■	■	■	■	
Cyclamen Opal F (398)	■	■	■	■	
Dark Indigo F (288)	■	■	■	■	
Emerald F (205)	■	■	■	■	New!
Erinite F (360)	■	■	■	■	
Fern Green F (291)	New!	■	■	■	
Fuchsia F (502)	■	■	■	■	
Greige F (284)	■	■	■	■	
Indian Sapphire F (217)	■	■	■	■	
Indicolite F (379)	■	■	■	■	
Jonquil F (213)	■	■	■	■	
Khaki F (550)	■	■	■	■	
Light Amethyst F (212)	■	■	■	■	
Light Azore F (361)	■	■	■	■	
Light Peach F (362)	■	■	■	■	
Light Rose F (223)	■	■	■	■	
Light Smoked Topaz F (221)	■	■	■	■	
Light Topaz F (226)	■	■	■	■	
Mocca F (286)	■	■	■	■	New!
Montana F (207)	■	■	■	■	New!
Pacific Opal F (390)	■	■	■	■	
Padparadscha F (542)	■	■	■	■	
Peridot F (214)	■	■	■	■	
Provence Lavender (283)	■	■	■	■	
Purple Velvet F (277)	■	■	■	■	
Rose F (209)	■	■	■	■	
Rose Water Opal F (395)	■	■	■	■	
Sand Opal F (287)	■	■	■	■	

4120

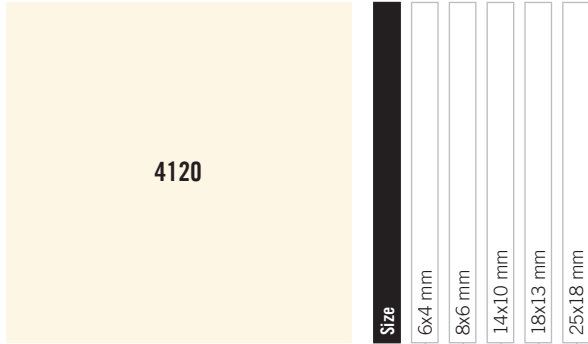

Colour	6x4 mm	8x6 mm	14x10 mm	18x13 mm	25x18 mm
Sapphire F (206)			■	■	
Siam F (208)	■	■	■	■	
Smoked Topaz F (220)			■	■	New!
Smoky Quartz F (225)			■	■	New!
Tanzanite F (539)	■	■	■	■	New!
Topaz F (203)			■	■	
Vintage Rose F (319)	■	■	■	■	New!
Violet F (371)			■	■	
White Alabaster F (281)			■	■	
White Opal F (234)			■	■	

4120/S

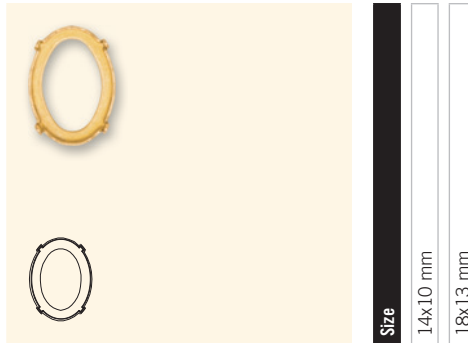

Ring/Hole, Back Configuration	14x10 mm	18x13 mm
00 C = No ring/hole, closed	■	■
H2 O = 4 holes/2 each side, open	■	■



00 C



H2 O

# Fancy Stones & Settings

4127

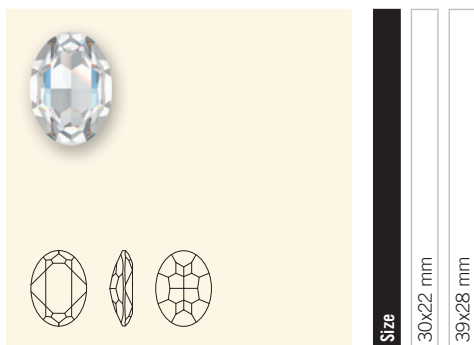

Size  
30x22 mm  
39x28 mm

### Colour

	Crystal F (001)	<input type="checkbox"/>	<input type="checkbox"/>
	Crystal AB F (001 AB)	<input type="checkbox"/>	<input type="checkbox"/>
	Crystal Golden Shadow F (001 GSHA)	<input type="checkbox"/>	<input type="checkbox"/>
	Crystal Red Magma F (001 REDM)	<input type="checkbox"/>	<input type="checkbox"/>
	Crystal Silver Shade F (001 SSHA)	<input type="checkbox"/>	<input type="checkbox"/>
	Crystal Vitrail Medium (001 VM)	<input type="checkbox"/>	<input type="checkbox"/>
	Jet (280)	<input type="checkbox"/>	<input type="checkbox"/>
	Jet Hematite (280 HEM)	<input type="checkbox"/>	<input type="checkbox"/>
	Jet Metallic Silver (280 METSI)	<input type="checkbox"/>	<input type="checkbox"/>
	Jet Nut (280 NUT)	<input type="checkbox"/>	<input type="checkbox"/>
	Amethyst F (204)	<input type="checkbox"/>	<input type="checkbox"/>
	Aquamarine F (202)	<input type="checkbox"/>	<input type="checkbox"/>
	Black Diamond F (215)	<input type="checkbox"/>	<input type="checkbox"/>
	Burgundy F (515)	<input type="checkbox"/>	<input type="checkbox"/>
	Chrysolite F (238)	<input type="checkbox"/>	<input type="checkbox"/>
	Fuchsia F (502)	<input type="checkbox"/>	<input type="checkbox"/>
	Light Colorado Topaz F (246)	<input type="checkbox"/>	<input type="checkbox"/>
	Light Rose F (223)	<input type="checkbox"/>	<input type="checkbox"/>
	Montana F (207)	<input type="checkbox"/>	<input type="checkbox"/>
	Tanzanite F (539)	<input type="checkbox"/>	<input type="checkbox"/>
	White Opal F (234)	<input type="checkbox"/>	<input type="checkbox"/>

4127/S

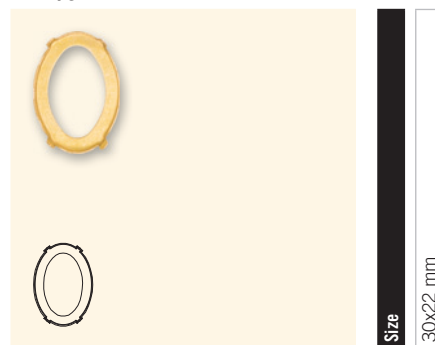

Size  
30x22 mm

### Ring/Hole, Back Configuration

00 C = No ring/hole, closed

H2 O = 4 holes/2 each side, open



00 C



H2 O



# Fancy Stones & Settings

## 4128 XILION Oval\*

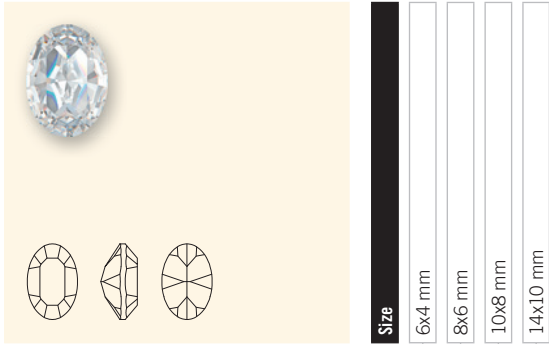

Colour	6x4 mm	8x6 mm	10x8 mm	14x10 mm
Crystal F (001)	■	■	■	■
Crystal AB F (001 AB)	■	■	■	■
Crystal Dorado (001 DOR)	■	■	■	■
Jet (280)	■	■	■	■
Jet Hematite (280 HEM)	■	■	■	■
Jet Metallic Silver (280 METSI)	■	■	■	■
Jet Nut (280 NUT)	■	■	■	■
Air Blue Opal F (285)	■	■	■	■
Amethyst F (204)	■	■	■	■
Aquamarine F (202)	■	■	■	■
Black Diamond F (215)	■	■	■	■
Caribbean Blue Opal F (394)	■	■	■	■
Emerald F (205)	■	■	■	■
Fuchsia F (502)	■	■	■	■
Jonquil F (213)	■	■	■	■
Light Amethyst F (212)	■	■	■	■
Light Grey Opal F (383)	■	■	■	■
Light Rose F (223)	■	■	■	■
Light Sapphire F (211)	■	■	■	■
Light Siam F (227)	■	■	■	■
Montana F (207)	■	■	■	■
Pacific Opal F (390)	■	■	■	■
Palace Green Opal F (393)	■	■	■	■
Peridot F (214)	■	■	■	■
Rose F (209)	■	■	■	■
Rose Water Opal F (395)	■	■	■	■
Sand Opal F (287)	■	■	■	■
Sapphire F (206)	■	■	■	■
Siam F (208)	■	■	■	■
Smoked Topaz F (220)	■	■	■	■
Topaz F (203)	■	■	■	■
White Opal F (234)	■	■	■	■

## 4128/S



Ring/Hole, Back Configuration	14x10 mm
00 C = No ring/hole, closed	■
H2 O = 4 holes/2 each side, open	■



\* Available as of September 2010! Until September 2010 art. 4100 is still available (please refer to former Collection for product details).



# Fancy Stones & Settings

## 4137 Cosmic Oval

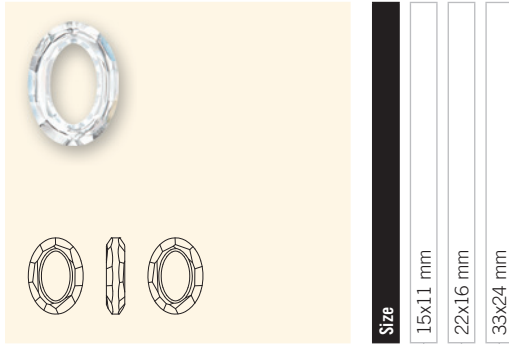

Colour	15x11 mm	22x16 mm	33x24 mm
Crystal (001)	■	■	■
Crystal CAL V SI (001 CAL)	■	■	■
Crystal Bermuda Blue (001 BBL)	■	■	■
Crystal Copper (001 COP)	■	■	■
Crystal Copper CAL V SI (001 COP)	■	■	■
Crystal Dorado (001 DOR)	■	■	■
Crystal Golden Shadow (001 GSHA)	■	■	■
Crystal Golden Shadow CAL V SI (001 GSHA)	■	■	■
Crystal Red Magma (001 REDM)	■	■	■
Crystal Sahara (001 SAH)	■	■	■
Crystal Silver Shade (001 SSHA)	■	■	■
Crystal Silver Shade CAL V SI (001 SSHA)	■	■	■
Crystal Tabac (001 TAB)	■	■	■
Crystal Vitrail Light (001 VL)	■	■	■
Crystal Volcano (001 VOL)	■	■	■
Jet (280)	■	■	■
Jet Hematite (280 HEM)	■	■	■
White Opal (234)	■	■	■

## 4139 Cosmic Ring

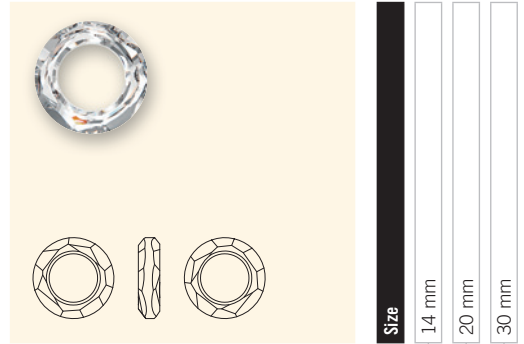

Colour	14 mm	20 mm	30 mm
Crystal (001)	■	■	■
Crystal CAL V SI (001)	■	■	■
Crystal Bermuda Blue (001 BBL)	■	■	■
Crystal Copper (001 COP)	■	■	■
Crystal Copper CAL V SI (001 COP)	■	■	■
Crystal Dorado (001 DOR)	■	■	■
Crystal Golden Shadow (001 GSHA)	■	■	■
Crystal Golden Shadow CAL V SI (001 GSHA)	■	■	■
Crystal Red Magma (001 REDM)	■	■	■
Crystal Sahara (001 SAH)	■	■	■
Crystal Silver Shade (001 SSHA)	■	■	■
Crystal Silver Shade CAL V SI (001 SSHA)	■	■	■
Crystal Tabac (001 TAB)	■	■	■
Crystal Vitrail Light (001 VL)	■	■	■
Crystal Volcano (001 VOL)	■	■	■
Jet (280)	■	■	■
Jet Hematite (280 HEM)	■	■	■
White Opal (234)	■	■	■

# Fancy Stones & Settings

## 4161 Long Classical Oval Fancy Stone

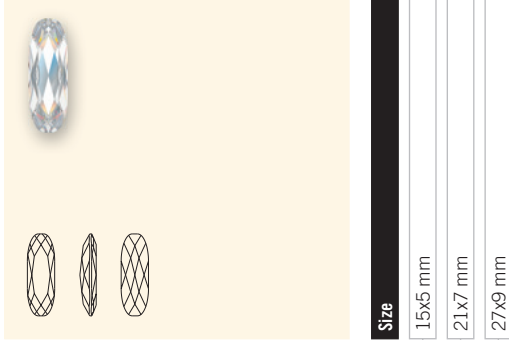

Colour	Size	15x5 mm	21x7 mm	27x9 mm
Crystal F (001)		■	■	■
Amethyst F (204)		■	■	■
Aquamarine F (202)		■	■	■
Indicolite F (379)		■	■	■
Jonquil F (213)		■	■	■
Light Colorado Topaz F (246)		■	■	■
Light Rose F (223)		■	■	■
Olivine F (228)		■	■	■
Padparadscha F (542)		■	■	■

## 4161/S

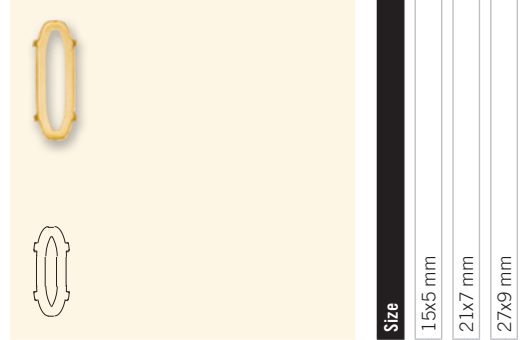

Ring/Hole, Back Configuration	Size	15x5 mm	21x7 mm	27x9 mm
00 C = No ring/hole, closed		■	■	■
H2 O = 4 holes/2 each side, open		■	■	■



## 4200

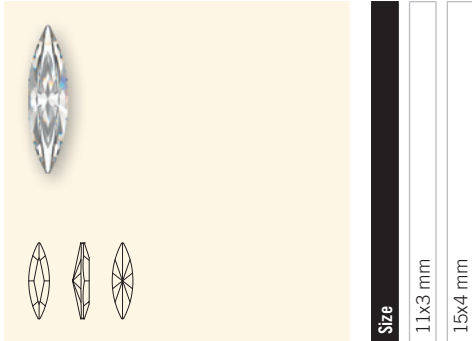

Colour	Size	11x3 mm	15x4 mm
Crystal F (001)		■	■
Crystal AB F (001 AB)	New!	■	■
Crystal Golden Shadow (001 GSHA)	New!	■	■
Crystal Silver Shade (001 SSHA)	New!	■	■
Jet (280)		■	■

# Fancy Stones & Settings

4227



Size

32x17 mm

**Colour**

- Crystal F (001)
- Crystal AB F (001 AB)
- Crystal Golden Shadow F (001 GSHA)
- Crystal Silver Shade F (001 SSHA)
- Jet (280)

4227/S

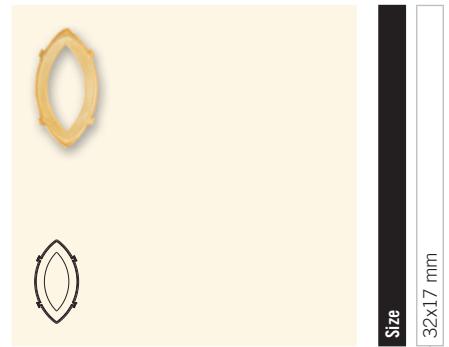

Size

32x17 mm

**Ring/Hole, Back Configuration**

- 00 C** = No ring/hole, closed
- H2 O** = 4 holes/2 each side, open

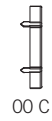



# Fancy Stones & Settings

4228

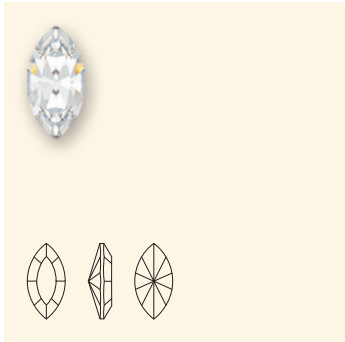

Size 4x2, 5x2.5 mm



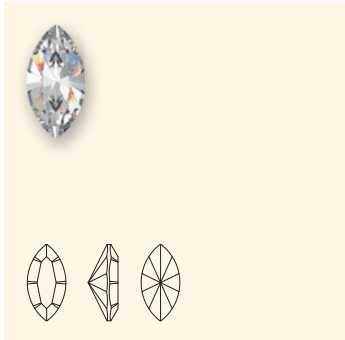





4228 XILION Navette



Size 6x3, 8x4, 10x5, 15x7 mm

4228		Size	4x2 mm	5x2.5 mm	6x3 mm	8x4 mm	10x5 mm	15x7 mm
Colour								
	Crystal F (001)		■	■	■	■	■	■
	Crystal AB F (001 AB)		■	■	■	■	■	■
	Crystal Golden Shadow F (001 GSHA)		■		■	■	■	■
	Crystal Metallic Light Gold F (001 MLGLD)				■	■	■	
	Crystal Moonlight F (001 MOL)		■		■	■	■	■
	Crystal Silver Shade F (001 SSHA)		■		■	■	■	■
	Jet (280)		■	■	■	■	■	■
	Jet Hematite (280 HEM)	New!	■	■	■	■	■	■
	Air Blue Opal F (285)				■	■	■	■
	Amethyst F (204)		■	■	■	■	■	■
	Aquamarine F (202)		■	■	■	■	■	■
	Black Diamond F (215)		■	■	■	■	■	■
	Chrysolite F (238)		■		■	■	■	■
	Cyclamen Opal F (398)				■	■	■	■
	Dark Indigo F (288)				■	■	■	■
	Dark Siam F (308)		■					
	Emerald F (205)		■	■	■	■	■	■
	Fern Green F (291)				■	■	■	■
	Fuchsia F (502)		■	■	■	■	■	■
	Indian Pink F (289)				■	■	■	■
	Greige F (284)				■	■	■	■
	Indicolite F (379)		■		■	■	■	■
	Jonquil F (213)		■	■	■	■	■	■
	Light Amethyst F (212)		■	■	■	■	■	■
	Light Azore F (361)		■		■	■	■	■
	Light Colorado Topaz F (246)		■	■	■	■	■	■
	Light Rose F (223)		■	■	■	■	■	■
	Light Sapphire F (211)		■	■	■	■	■	■
	Light Siam F (227)		■	■	■	■	■	■
	Mocca F (286)		■		■	■	■	■
	Montana F (207)		■	■	■	■	■	■
	Olivine F (228)		■	■	■	■	■	■
	Pacific Opal F (390)		■		■	■	■	■
	Padparadscha F (542)		■		■	■	■	■
	Palace Green Opal F (393)		■		■	■	■	■
	Peridot F (214)		■	■	■	■	■	■
	Provence Lavender F (283)				■	■	■	■
	Purple Velvet F (277)		■		■	■	■	■
	Rose F (209)		■	■	■	■	■	■

# Fancy Stones & Settings

4228		Size	4x2 mm	5x2.5 mm	6x3 mm	8x4 mm	10x5 mm	15x7 mm
Colour								
 Sand Opal F (287)		■		■	■	■	■	■
 Sapphire F (206)		■	■	■	■	■	■	■
 Siam F (208)		■	■	■	■	■	■	■
 Smoked Topaz F (220)		■	■	■	■	■	■	■
 Smoky Quartz F (225)		■		■	■	■	■	■
 Tanzanite F (539)		■		■	■	■	■	■
 Topaz F (203)		■	■	■	■	■	■	■
 White Opal F (234)		■		■	■	■	■	■

# Fancy Stones & Settings

4320



Size	6x4 mm	8x6 mm	10x7 mm	14x10 mm	18x13 mm
------	--------	--------	---------	----------	----------

**Colour**

Crystal F (001)	■	■	■	■	■
Crystal AB F (001 AB)	■	■	■	■	■
Crystal Copper F (001 COP)	■	■	■	■	■
Crystal Golden Shadow F (001 GSHA)	■	■	■	■	■
Crystal Metallic Light Gold F (001 MLGLD)	■	■	■	■	■
Crystal Moonlight F (001 MOL)	■	■	■	■	■
Crystal Silver Shade F (001 SSHA)	■	■	■	■	■
Jet (280)	■	■	■	■	■
Air Blue Opal F (285)	■	■	■	■	■
Amethyst F (204)	■	■	■	■	■
Aquamarine F (202)	■	■	■	■	■
Black Diamond F (215)	■	■	■	■	■
Caribbean Blue Opal F (394)	■	■	■	■	■
Cyclamen Opal F (398)	■	■	■	■	■
Dark Indigo F (288)	■	■	■	■	■
Emerald F (205)	■	■	■	■	■
Fern Green F (291)	■	■	■	■	■
Greige F (284)	■	■	■	■	■
Khaki F (550)	■	■	■	■	■
Light Colorado Topaz F (246)	■	■	■	■	■
Light Grey Opal F (383)	■	■	■	■	■
Montana F (207)	■	■	■	■	■
Olivine F (228)	■	■	■	■	■
Pacific Opal F (390)	■	■	■	■	■
Padparadscha F (542)	■	■	■	■	■
Palace Green Opal F (393)	■	■	■	■	■
Provence Lavender F (283)	■	■	■	■	■
Purple Velvet F (277)	■	■	■	■	■
Rose F (209)	■	■	■	■	■
Rose Water Opal F (395)	■	■	■	■	■
Siam F (208)	■	■	■	■	■
Tanzanite F (539)	■	■	■	■	■
Topaz F (203)	■	■	■	■	■
Vintage Rose F (319)	■	■	■	■	■
White Opal F (234)	■	■	■	■	■

4320/S

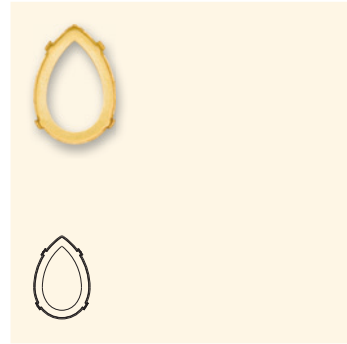

Size	18x13 mm
------	----------

**Ring/Hole, Back Configuration**

- 00 C = No ring/hole, closed
- H2 O = 4 holes/2 each side, open



Fancy Stones & Settings



# Fancy Stones & Settings

4327



Size  
30x20 mm  
40x27 mm

**Colour**

- Crystal F (001)
- Crystal AB F (001 AB)
- Crystal Golden Shadow F (001 GSHA)
- Crystal Red Magma F (001 REDM)
- Crystal Silver Shade F (001 SSHA)
- Crystal Vitrail Medium (001 VM)
- Jet (280)
- Jet Hematite (280 HEM)
- Jet Metallic Silver (280 METSI)
- Jet Nut (280 NUT)
  
- Amethyst F (204)
- Aquamarine F (202)
- Black Diamond F (215)
- Burgundy F (515)
- Chrysolite F (238)
- Fuchsia F (502)
- Light Colorado Topaz F (246)
- Light Rose F (223)
- Montana F (207)
- Tanzanite F (539)
- White Opal F (234)

4327/S

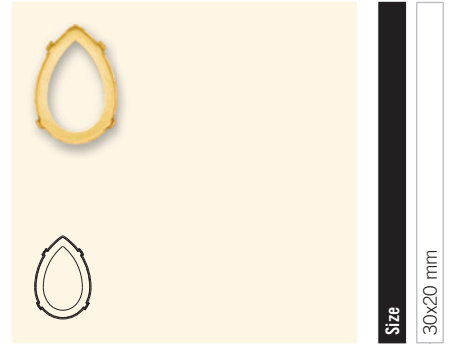

Size  
30x20 mm

**Ring/Hole, Back Configuration**

- 00 C = No ring/hole, closed
- H2 O = 4 holes/2 each side, open



00 C



H2 O

# Fancy Stones & Settings

01 Fancy Stones & Settings

## 4328 XILION Pear



Size
6x3.6 mm
8x4.8 mm
10x6 mm
13x7.8 mm

Colour	6x3.6 mm	8x4.8 mm	10x6 mm	13x7.8 mm
Crystal F (001)	■	■	■	■
Crystal AB F (001 AB)	■	■	■	■
Crystal Golden Shadow F (001 GSHA)	■	■	■	■
Crystal Silver Shade F (001 SSHA)	■	■	■	■
Jet (280)	■	■	■	■
Amethyst F (204)	■	■	■	■
Aquamarine F (202)	■	■	■	■
Black Diamond F (215)	■	■	■	■
Emerald F (205)	■	■	■	■
Fern Green F (291)	■	■	■	■
Fuchsia F (502)	■	■	■	■
Khaki F (550)	■	■	■	■
Light Amethyst F (212)	■	■	■	■
Light Colorado Topaz F (246)	■	■	■	■
Light Rose F (223)	■	■	■	■
Light Sapphire F (211)	■	■	■	■
Light Siam F (227)	■	■	■	■
Montana F (207)	■	■	■	■
Peridot F (214)	■	■	■	■
Provence Lavender F (283)	■	■	■	■
Siam F (208)	■	■	■	■
Smoked Topaz F (220)	■	■	■	■
Tanzanite F (539)	■	■	■	■
Topaz F (203)	■	■	■	■
White Opal F (234)	■	■	■	■

## 4335 Mini Pear Fancy Stone



Size
3.5 mm

Colour	3.5 mm
Crystal F (001)	■
Aquamarine F (202)	■
Black Diamond F (215)	■
Dark Siam F (308)	■
Indian Siam F (327)	■
Light Amethyst F (212)	■
Light Colorado Topaz F (246)	■
Light Rose F (223)	■
Peridot F (214)	■

# Fancy Stones & Settings

4370



**Colour**

- Crystal (001)
- Crystal F (001)
- Crystal Golden Shadow (001 GSHA) *New!*
- Tanzanite (539)

Size			
	11x10 mm		
	15.5x14 mm		
	20x18 mm		

# Fancy Stones & Settings

4428

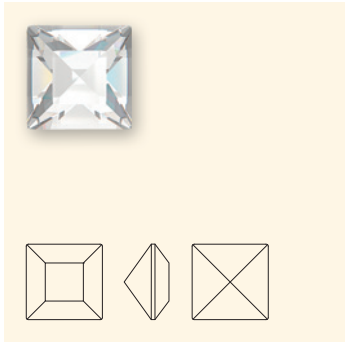

Size 2 mm

4428 XILION Square



Size 3, 4 mm

4428 XILION Square

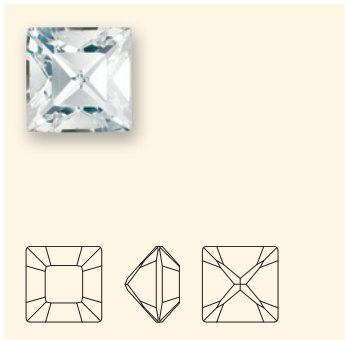

Size 5, 6, 8 mm

4428		Size	2 mm	3 mm	4 mm	5 mm	6 mm	8 mm
Colour								
	Crystal F (001)		■	■	■	■	■	■
	Crystal AB F (001 AB)		■	■	■	■	■	■
	Crystal Golden Shadow F (001 GSHA)		■	■	■	■	■	■
	Crystal Metallic Light Gold F (001 MLGLD)		■	■	■	■	■	■
	Crystal Silver Shade F (001 SSHA)		■	■	■	■	■	■
	Jet (280)		■	■	■	■	■	■
	Jet Hematite (280 HEM)	New!	■	■	■	■	■	■
	Air Blue Opal F (285)		■	■	■	■	■	■
	Amethyst F (204)		■	■	■	■	■	■
	Aquamarine F (202)		■	■	■	■	■	■
	Black Diamond F (215)		■	■	■	■	■	■
	Burgundy F (515)		■	■	■	■	■	■
	Cyclamen Opal F (398)		■	■	■	■	■	■
	Dark Indigo F (288)		■	■	■	■	■	■
	Dark Siam F (308)		■	■	■	■	■	■
	Emerald F (205)		■	■	■	■	■	■
	Fern Green F (291)		■	■	■	■	■	■
	Fuchsia F (502)		■	■	■	■	■	■
	Greige F (284)		■	■	■	■	■	■
	Indicolite F (379)		■	■	■	■	■	■
	Jonquil F (213)		■	■	■	■	■	■
	Light Amethyst F (212)		■	■	■	■	■	■
	Light Colorado Topaz F (246)		■	■	■	■	■	■
	Light Peach F (362)		■	■	■	■	■	■
	Light Rose F (223)		■	■	■	■	■	■
	Light Sapphire F (211)		■	■	■	■	■	■
	Light Siam F (227)		■	■	■	■	■	■
	Light Smoked Topaz F (221)		■	■	■	■	■	■
	Montana F (207)		■	■	■	■	■	■
	Pacific Opal F (390)		■	■	■	■	■	■
	Peridot F (214)		■	■	■	■	■	■
	Provence Lavender F (283)		■	■	■	■	■	■
	Rose F (209)		■	■	■	■	■	■
	Sapphire F (206)		■	■	■	■	■	■
	Siam F (208)		■	■	■	■	■	■
	Smoked Topaz F (220)		■	■	■	■	■	■
	Smoky Quartz F (225)		■	■	■	■	■	■
	Tanzanite F (539)		■	■	■	■	■	■
	Topaz F (203)		■	■	■	■	■	■

# Fancy Stones & Settings

**4428**



**Size**

- 2 mm
- 3 mm
- 4 mm
- 5 mm
- 6 mm
- 8 mm

**Colour**

- Violet F (371)
- White Opal F (234)

**4428/S**

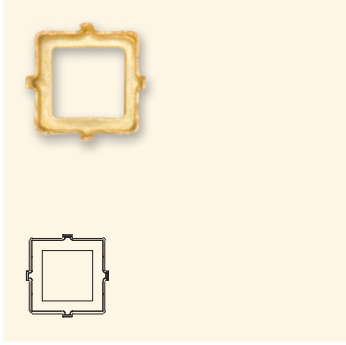

**Size**

- 6 mm
- 8 mm

**Ring/Hole, Back Configuration**

- 00 C** = No ring/hole, closed
- H2 O** = 4 holes/2 each side, open



# Fancy Stones & Settings

## 4437 Cosmic Square Ring



Size	14 mm	20 mm	30 mm
------	-------	-------	-------

Colour	14 mm	20 mm	30 mm
Crystal (001)	■	■	■
Crystal CAL V SI (001 CAL)	■	■	■
Crystal Bermuda Blue (001 BBL)	■	■	
Crystal Copper (001 COP)	■	■	
Crystal Copper CAL V SI (001 COP)	■	■	
Crystal Dorado (001 DOR)	■	■	
Crystal Golden Shadow (001 GSHA)	■	■	■
Crystal Golden Shadow CAL V SI (001 GSHA)	■	■	
Crystal Red Magma (001 REDM)	■	■	
Crystal Sahara (001 SAH)	■	■	
Crystal Silver Shade (001 SSHA)	■	■	■
Crystal Silver Shade CAL V SI (001 SSHA)	■	■	
Crystal Tabac (001 TAB)	■	■	
Crystal Vitrail Light (001 VL)	■	■	
Crystal Volcano (001 VOL)	■	■	
Jet (280)	■	■	■
White Opal (234)	■	■	■

New!

## 4439 Square Ring

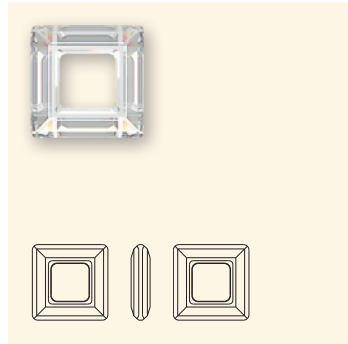

Size	14 mm	20 mm	30 mm
------	-------	-------	-------

Colour	14 mm	20 mm	30 mm
Crystal (001)	■	■	■
Crystal CAL V SI (001)	■	■	■
Crystal Bermuda Blue (001 BBL)	■	■	
Crystal Copper (001 COP)	■	■	
Crystal Copper CAL V SI (001 COP)	■	■	
Crystal Dorado (001 DOR)	■	■	
Crystal Golden Shadow (001 GSHA)	■	■	■
Crystal Golden Shadow CAL V SI (001 GSHA)	■	■	
Crystal Red Magma (001 REDM)	■	■	
Crystal Sahara (001 SAH)	■	■	
Crystal Silver Shade (001 SSHA)	■	■	■
Crystal Silver Shade CAL V SI (001 SSHA)	■	■	
Crystal Tabac (001 TAB)	■	■	
Crystal Vitrail Light (001 VL)	■	■	
Crystal Volcano (001 VOL)	■	■	
Jet (280)	■	■	■
Jet Hematite (280 HEM)	■	■	■
White Opal (234)	■	■	■

New!

New!

# Fancy Stones & Settings

## 4447 Princess Square Fancy Stone



Colour	6 mm	8 mm	10 mm	12 mm
Crystal F (001)	■	■	■	■
Crystal Golden Shadow F (001 GSHA)	■	■	■	■
Crystal Silver Shade F (001 SSHA)	■	■	■	■
Aquamarine F (202)				■
Light Amethyst F (212)				■
Light Rose F (223)				■
Light Sapphire F (211)				■
Light Siam F (227)				■
Light Smoked Topaz F (221)				■
Tanzanite F (539)				■
White Opal F (234)				■

## 4447/S

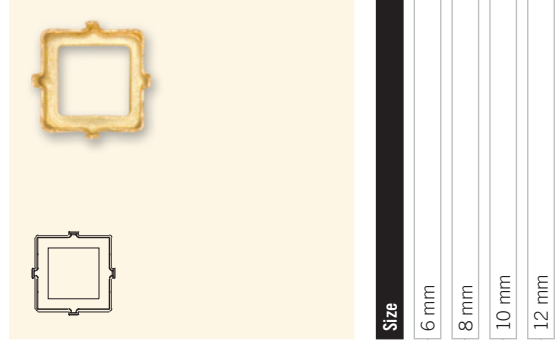

Ring/Hole, Back Configuration	6 mm	8 mm	10 mm	12 mm
00 C = No ring/hole, closed	■	■	■	■
H2 O = 4 holes/2 each side, open	■	■	■	■



00 C



H2 O

## 4461 Classical Square Fancy Stone

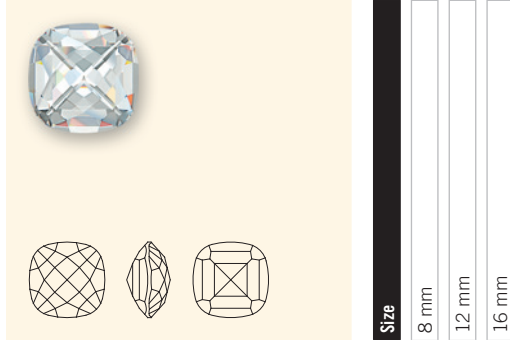

Colour	8 mm	12 mm	16 mm
Crystal F (001)	■	■	■
Crystal Golden Shadow F (001 GSHA)	■	■	■
Crystal Silver Shade F (001 SSHA)	■	■	■
Crystal Satin F (001 SAT)	■	■	■

## 4461/S

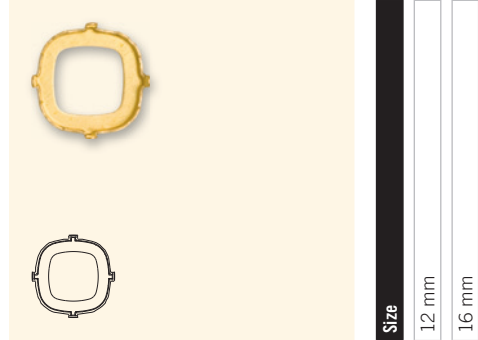

Ring/Hole, Back Configuration	12 mm	16 mm
00 C = No ring/hole, closed	■	■
H2 O = 4 holes/2 each side, open	■	■



00 C



H2 O



# Fancy Stones & Settings

4470



Size	10 mm	12 mm	18 mm
------	-------	-------	-------

**Colour**

Crystal (001) <span style="float: right; font-size: small;">New</span>	<input type="checkbox"/>	<input type="checkbox"/>	<input type="checkbox"/>
Crystal F (001)	<input type="checkbox"/>	<input type="checkbox"/>	<input type="checkbox"/>
Crystal Copper F (001 COP)	<input type="checkbox"/>	<input type="checkbox"/>	<input type="checkbox"/>
Crystal Golden Shadow (001 GSHA)	<input type="checkbox"/>	<input type="checkbox"/>	<input type="checkbox"/>
Crystal Golden Shadow F (001 GSHA)	<input type="checkbox"/>	<input type="checkbox"/>	<input type="checkbox"/>
Crystal Metallic Light Gold F (001 MLGLD)	<input type="checkbox"/>	<input type="checkbox"/>	<input type="checkbox"/>
Crystal Moonlight F (001 MOL)	<input type="checkbox"/>	<input type="checkbox"/>	<input type="checkbox"/>
Crystal Silver Shade (001 SSHA)	<input type="checkbox"/>	<input type="checkbox"/>	<input type="checkbox"/>
Crystal Silver Shade F (001 SSHA)	<input type="checkbox"/>	<input type="checkbox"/>	<input type="checkbox"/>
Jet (280)	<input type="checkbox"/>	<input type="checkbox"/>	<input type="checkbox"/>
Air Blue Opal F (285)	<input type="checkbox"/>	<input type="checkbox"/>	<input type="checkbox"/>
Aquamarine F (202)	<input type="checkbox"/>	<input type="checkbox"/>	<input type="checkbox"/>
Black Diamond F (215)	<input type="checkbox"/>	<input type="checkbox"/>	<input type="checkbox"/>
Burgundy F (515)	<input type="checkbox"/>	<input type="checkbox"/>	<input type="checkbox"/>
Caribbean Blue Opal F (394)	<input type="checkbox"/>	<input type="checkbox"/>	<input type="checkbox"/>
Chrysolite F (238)	<input type="checkbox"/>	<input type="checkbox"/>	<input type="checkbox"/>
Cyclamen Opal (398)	<input type="checkbox"/>	<input type="checkbox"/>	<input type="checkbox"/>
Cyclamen Opal F (398)	<input type="checkbox"/>	<input type="checkbox"/>	<input type="checkbox"/>
Dark Indigo F (288)	<input type="checkbox"/>	<input type="checkbox"/>	<input type="checkbox"/>
Erinite F (360)	<input type="checkbox"/>	<input type="checkbox"/>	<input type="checkbox"/>
Fern Green (291)	<input type="checkbox"/>	<input type="checkbox"/>	<input type="checkbox"/>
Fern Green F (291)	<input type="checkbox"/>	<input type="checkbox"/>	<input type="checkbox"/>
Greige (284)	<input type="checkbox"/>	<input type="checkbox"/>	<input type="checkbox"/>
Greige F (284)	<input type="checkbox"/>	<input type="checkbox"/>	<input type="checkbox"/>
Indian Pink F (289)	<input type="checkbox"/>	<input type="checkbox"/>	<input type="checkbox"/>
Indicolite F (379)	<input type="checkbox"/>	<input type="checkbox"/>	<input type="checkbox"/>
Khaki F (550)	<input type="checkbox"/>	<input type="checkbox"/>	<input type="checkbox"/>
Light Azure F (361)	<input type="checkbox"/>	<input type="checkbox"/>	<input type="checkbox"/>
Light Colorado Topaz F (246)	<input type="checkbox"/>	<input type="checkbox"/>	<input type="checkbox"/>
Light Grey Opal F (383)	<input type="checkbox"/>	<input type="checkbox"/>	<input type="checkbox"/>
Light Peach F (362)	<input type="checkbox"/>	<input type="checkbox"/>	<input type="checkbox"/>
Light Smoked Topaz F (221)	<input type="checkbox"/>	<input type="checkbox"/>	<input type="checkbox"/>
Light Topaz F (226)	<input type="checkbox"/>	<input type="checkbox"/>	<input type="checkbox"/>
Mocca F (286)	<input type="checkbox"/>	<input type="checkbox"/>	<input type="checkbox"/>
Pacific Opal F (390)	<input type="checkbox"/>	<input type="checkbox"/>	<input type="checkbox"/>
Padparadscha F (542)	<input type="checkbox"/>	<input type="checkbox"/>	<input type="checkbox"/>
Palace Green Opal F (393)	<input type="checkbox"/>	<input type="checkbox"/>	<input type="checkbox"/>
Purple Velvet F (277)	<input type="checkbox"/>	<input type="checkbox"/>	<input type="checkbox"/>
Provence Lavender (283)	<input type="checkbox"/>	<input type="checkbox"/>	<input type="checkbox"/>

4470



Size	10 mm	12 mm	18 mm
------	-------	-------	-------

**Colour**

Provence Lavender F (283)	<input type="checkbox"/>	<input type="checkbox"/>	<input type="checkbox"/>
Rose Water Opal F (395)	<input type="checkbox"/>	<input type="checkbox"/>	<input type="checkbox"/>
Sand Opal F (287)	<input type="checkbox"/>	<input type="checkbox"/>	<input type="checkbox"/>
Siam F (208)	<input type="checkbox"/>	<input type="checkbox"/>	<input type="checkbox"/>
Smoked Topaz F (220)	<input type="checkbox"/>	<input type="checkbox"/>	<input type="checkbox"/>
Smoky Quartz F (225)	<input type="checkbox"/>	<input type="checkbox"/>	<input type="checkbox"/>
Tanzanite F (539)	<input type="checkbox"/>	<input type="checkbox"/>	<input type="checkbox"/>
Vintage Rose F (319)	<input type="checkbox"/>	<input type="checkbox"/>	<input type="checkbox"/>
Violet F (371)	<input type="checkbox"/>	<input type="checkbox"/>	<input type="checkbox"/>
White Opal F (234)	<input type="checkbox"/>	<input type="checkbox"/>	<input type="checkbox"/>

4470/S

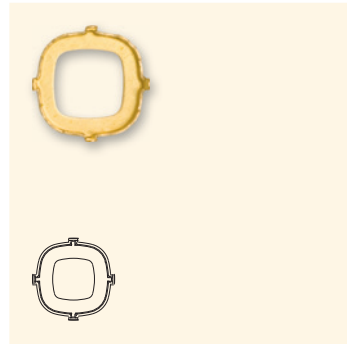

Size	10 mm	12 mm
------	-------	-------

**Ring/Hole, Back Configuration**

<b>00 C</b> = No ring/hole, closed	<input type="checkbox"/>	<input type="checkbox"/>
<b>H2 O</b> = 4 holes/2 each side, open	<input type="checkbox"/>	<input type="checkbox"/>



# Fancy Stones & Settings

4500

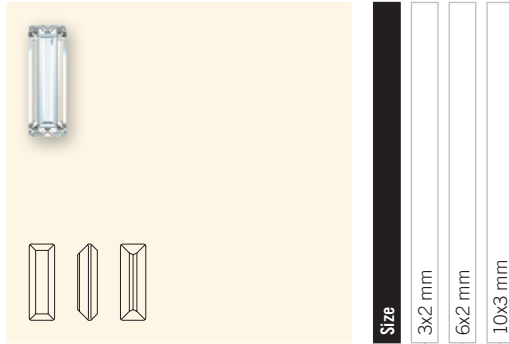

Colour		Size	3x2 mm	6x2 mm	10x3 mm
Crystal F (001)	<input type="checkbox"/>	<input type="checkbox"/>	<input type="checkbox"/>	<input type="checkbox"/>	<input type="checkbox"/>
Jet (280)	<input type="checkbox"/>	<input type="checkbox"/>	<input type="checkbox"/>	<input type="checkbox"/>	<input type="checkbox"/>
Amethyst F (204)	<input type="checkbox"/>	<input type="checkbox"/>	<input type="checkbox"/>	<input type="checkbox"/>	<input type="checkbox"/>
Aquamarine F (202)	<input type="checkbox"/>	<input type="checkbox"/>	<input type="checkbox"/>	<input type="checkbox"/>	<input type="checkbox"/>
Black Diamond F (215)	<input type="checkbox"/>	<input type="checkbox"/>	<input type="checkbox"/>	<input type="checkbox"/>	<input type="checkbox"/>
Emerald F (205)	<input type="checkbox"/>	<input type="checkbox"/>	<input type="checkbox"/>	<input type="checkbox"/>	<input type="checkbox"/>
Jonquil F (213)	<input type="checkbox"/>	<input type="checkbox"/>	<input type="checkbox"/>	<input type="checkbox"/>	<input type="checkbox"/>
Light Amethyst F (212)	<input type="checkbox"/>	<input type="checkbox"/>	<input type="checkbox"/>	<input type="checkbox"/>	<input type="checkbox"/>
Light Rose F (223)	<input type="checkbox"/>	<input type="checkbox"/>	<input type="checkbox"/>	<input type="checkbox"/>	<input type="checkbox"/>
Light Sapphire F (211)	<input type="checkbox"/>	<input type="checkbox"/>	<input type="checkbox"/>	<input type="checkbox"/>	<input type="checkbox"/>
Light Siam F (227)	<input type="checkbox"/>	<input type="checkbox"/>	<input type="checkbox"/>	<input type="checkbox"/>	<input type="checkbox"/>
Light Smoked Topaz F (221)	<input type="checkbox"/>	<input type="checkbox"/>	<input type="checkbox"/>	<input type="checkbox"/>	<input type="checkbox"/>
Montana F (207)	<input type="checkbox"/>	<input type="checkbox"/>	<input type="checkbox"/>	<input type="checkbox"/>	<input type="checkbox"/>
Peridot F (214)	<input type="checkbox"/>	<input type="checkbox"/>	<input type="checkbox"/>	<input type="checkbox"/>	<input type="checkbox"/>
Rose F (209)	<input type="checkbox"/>	<input type="checkbox"/>	<input type="checkbox"/>	<input type="checkbox"/>	<input type="checkbox"/>
Sapphire F (206)	<input type="checkbox"/>	<input type="checkbox"/>	<input type="checkbox"/>	<input type="checkbox"/>	<input type="checkbox"/>
Siam F (208)	<input type="checkbox"/>	<input type="checkbox"/>	<input type="checkbox"/>	<input type="checkbox"/>	<input type="checkbox"/>
Smoked Topaz F (220)	<input type="checkbox"/>	<input type="checkbox"/>	<input type="checkbox"/>	<input type="checkbox"/>	<input type="checkbox"/>
Topaz F (203)	<input type="checkbox"/>	<input type="checkbox"/>	<input type="checkbox"/>	<input type="checkbox"/>	<input type="checkbox"/>



# Fancy Stones & Settings

4501

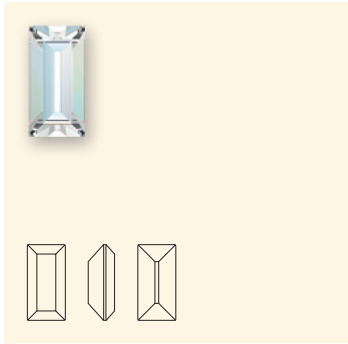

Size	4x2 mm	5x2 mm	5x2.5 mm	7x3 mm	10x5 mm
------	--------	--------	----------	--------	---------

**Colour**

Crystal (001)	■	■	■	■	■
Crystal F (001)	■	■	■	■	■
Crystal AB F (001 AB)	■	■	■	■	■
Crystal Golden Shadow F (001 GSHA)	■	■	■	■	■
Jet (280)	■	■	■	■	■
Jet Hermitite (280 HEM) <small>New!</small>	■	■	■	■	■
Amethyst F (204)	■	■	■	■	■
Aquamarine F (202)	■	■	■	■	■
Black Diamond F (215)	■	■	■	■	■
Dark Siam F (308)	■	■	■	■	■
Emerald F (205)	■	■	■	■	■
Erinite F (360)	■	■	■	■	■
Fuchsia F (502)	■	■	■	■	■
Jonquil F (213)	■	■	■	■	■
Light Amethyst F (212)	■	■	■	■	■
Light Peach F (362)	■	■	■	■	■
Light Rose F (223)	■	■	■	■	■
Light Sapphire F (211)	■	■	■	■	■
Light Siam F (227)	■	■	■	■	■
Light Smoked Topaz F (221)	■	■	■	■	■
Light Topaz F (226)	■	■	■	■	■
Montana F (207)	■	■	■	■	■
Padparadscha F (542)	■	■	■	■	■
Peridot F (214)	■	■	■	■	■
Rose F (209)	■	■	■	■	■
Sapphire F (206)	■	■	■	■	■
Siam F (208)	■	■	■	■	■
Smoked Topaz F (220)	■	■	■	■	■
Smoky Quartz F (225)	■	■	■	■	■
Tanzanite F (539)	■	■	■	■	■
Topaz F (203)	■	■	■	■	■
Violet F (371)	■	■	■	■	■
White Opal F (234)	■	■	■	■	■

4501/S

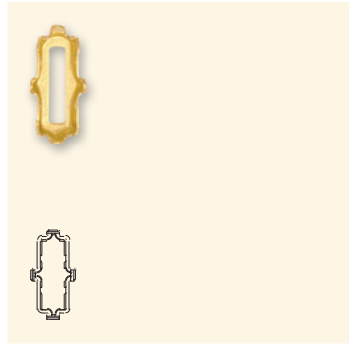

Size	7x3 mm
------	--------

**Ring/Hole, Back Configuration**

<b>00 C</b> = No ring/hole, closed	■
<b>H2 O</b> = 4 holes/2 each side, open	■

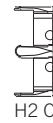
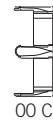

Fancy Stones & Settings

# Fancy Stones & Settings

## 4502

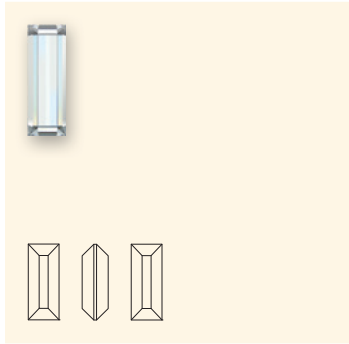

**Size**  
3x1 mm

**Colour**  
Crystal F (001)

## 4527 Step Cut Fancy Stone

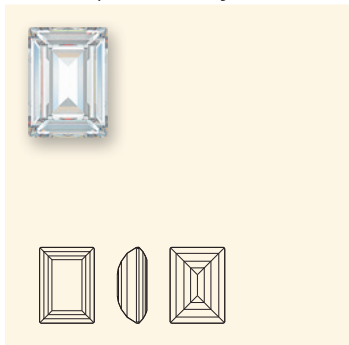

**Size**  
8x6 mm  
14x10 mm  
18x13 mm

**Colour**

- Crystal F (001)
- Crystal Golden Shadow F (001 GSHA)
- Crystal Silver Shade F (001 SSHA)
- Erinite F (360)
- Light Amethyst F (212)
- Light Azore F (361)
- Montana F (207)
- Smoky Quartz F (225)
- Tanzanite F (539)

## 4527/S

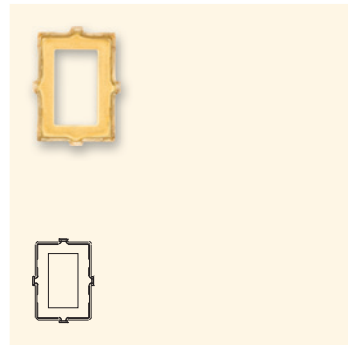

**Size**  
8x6 mm  
14x10 mm

**Ring/Hole, Back Configuration**

- 00 C = No ring/hole, closed
- H2 O = 4 holes/2 each side, open



00 C



H2 O

# Fancy Stones & Settings

## 4547 Princess Baguette Fancy Stone

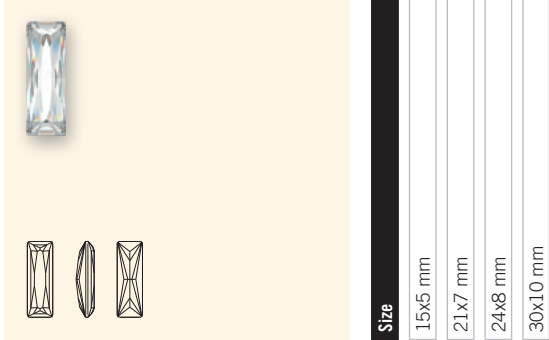

Colour	Size	15x5 mm	21x7 mm	24x8 mm	30x10 mm
Crystal F (001)		■	■	■	■
Crystal Copper F (001 COP)		■	■	■	■
Crystal Red Magma F (001 REDM)	<i>New!</i>	■	■	■	■
Crystal Golden Shadow F (001 GSHA)		■	■	■	■
Crystal Silver Shade F (001 SSHA)		■	■	■	■
Jet (280)		■	■	■	■
Aquamarine F (202)		■	■	■	■
Black Diamond F (215)		■	■	■	■
Burgundy F (515)		■	■	■	■
Erinite F (360)		■	■	■	■
Light Rose F (223)		■	■	■	■
Light Smoked Topaz F (221)		■	■	■	■
Padparadscha F (542)		■	■	■	■
Tanzanite F (539)		■	■	■	■

## 4547/S

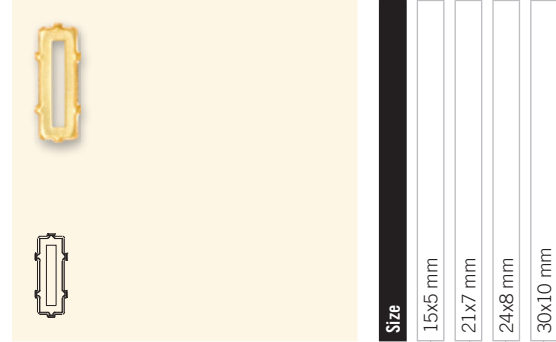

Ring/Hole, Back Configuration	Size	15x5 mm	21x7 mm	24x8 mm	30x10 mm
00 C = No ring/hole, closed		■	■	■	■
H2 O = 4 holes/2 each side, open		■	■	■	■

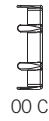

# Fancy Stones & Settings

## 4565 Classical Baguette Fancy Stone



Size  
14x10 mm  
18x13 mm

### Colour

<input type="checkbox"/>	Crystal (001)	<input type="checkbox"/>	<input type="checkbox"/>
<input type="checkbox"/>	Crystal F (001)	<input type="checkbox"/>	<input type="checkbox"/>
<input type="checkbox"/>	Crystal Golden Shadow F (001 GSHA)	<input type="checkbox"/>	<input type="checkbox"/>
<input type="checkbox"/>	Crystal Silver Shade F (001 SSHA) <i>New!</i>	<input type="checkbox"/>	<input type="checkbox"/>
<input type="checkbox"/>	Jet (280)	<input type="checkbox"/>	<input type="checkbox"/>
<input type="checkbox"/>	Aquamarine (202)	<input type="checkbox"/>	<input type="checkbox"/>
<input type="checkbox"/>	Aquamarine F (202)	<input type="checkbox"/>	<input type="checkbox"/>
<input type="checkbox"/>	Light Rose (223)	<input type="checkbox"/>	<input type="checkbox"/>
<input type="checkbox"/>	Light Rose F (223)	<input type="checkbox"/>	<input type="checkbox"/>
<input type="checkbox"/>	Tanzanite (539)	<input type="checkbox"/>	<input type="checkbox"/>
<input type="checkbox"/>	Tanzanite F (539)	<input type="checkbox"/>	<input type="checkbox"/>

## 4581 Stage Flat Fancy Stone

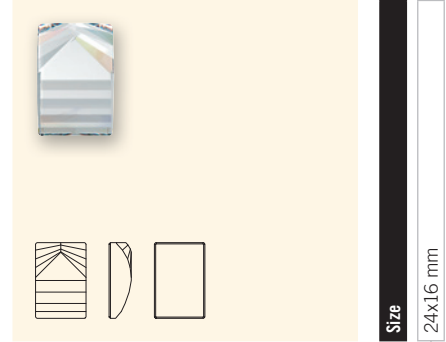

Size  
24x16 mm

### Colour

<input type="checkbox"/>	Crystal CAL V SI (001)	<input type="checkbox"/>	<input type="checkbox"/>
<input type="checkbox"/>	Crystal AB CAL V SI (001 AB)	<input type="checkbox"/>	<input type="checkbox"/>
<input type="checkbox"/>	Crystal Copper CAL V SI (001 COP)	<input type="checkbox"/>	<input type="checkbox"/>
<input type="checkbox"/>	Crystal Golden Shadow CAL V SI (001 GSHA)	<input type="checkbox"/>	<input type="checkbox"/>
<input type="checkbox"/>	Crystal Silver Shade CAL V SI (001 SSHA) <i>New!</i>	<input type="checkbox"/>	<input type="checkbox"/>
<input type="checkbox"/>	Crystal Satin CAL V SI (001 SAT)	<input type="checkbox"/>	<input type="checkbox"/>
<input type="checkbox"/>	Jet (280)	<input type="checkbox"/>	<input type="checkbox"/>
<input type="checkbox"/>	Jet Hematite (280 HEM)	<input type="checkbox"/>	<input type="checkbox"/>
<input type="checkbox"/>	Jet Metallic Silver (280 METSI)	<input type="checkbox"/>	<input type="checkbox"/>
<input type="checkbox"/>	Jet Nut (280 NUT)	<input type="checkbox"/>	<input type="checkbox"/>

## 4582 Step Cut Flat Fancy Stone

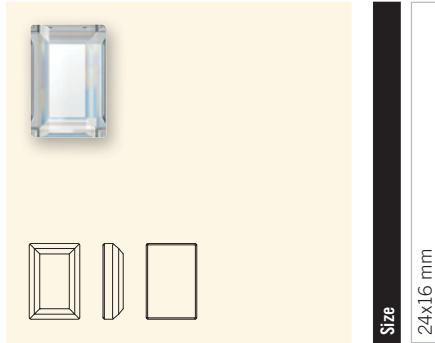

Size  
24x16 mm

### Colour

<input type="checkbox"/>	Crystal CAL V SI (001)	<input type="checkbox"/>	<input type="checkbox"/>
<input type="checkbox"/>	Crystal AB CAL V SI (001 AB)	<input type="checkbox"/>	<input type="checkbox"/>
<input type="checkbox"/>	Crystal Copper CAL V SI (001 COP)	<input type="checkbox"/>	<input type="checkbox"/>
<input type="checkbox"/>	Crystal Golden Shadow CAL V SI (001 GSHA)	<input type="checkbox"/>	<input type="checkbox"/>
<input type="checkbox"/>	Crystal Silver Shade CAL V SI (001 SSHA) <i>New!</i>	<input type="checkbox"/>	<input type="checkbox"/>
<input type="checkbox"/>	Crystal Satin CAL V SI (001 SAT)	<input type="checkbox"/>	<input type="checkbox"/>
<input type="checkbox"/>	Jet (280)	<input type="checkbox"/>	<input type="checkbox"/>
<input type="checkbox"/>	Jet Hematite (280 HEM)	<input type="checkbox"/>	<input type="checkbox"/>
<input type="checkbox"/>	Jet Metallic Silver (280 METSI)	<input type="checkbox"/>	<input type="checkbox"/>
<input type="checkbox"/>	Jet Nut (280 NUT)	<input type="checkbox"/>	<input type="checkbox"/>

## 4583 Graphic Flat Fancy Stone

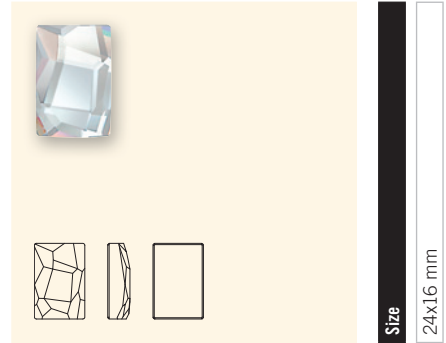

Size  
24x16 mm

### Colour

<input type="checkbox"/>	Crystal CAL V SI (001)	<input type="checkbox"/>	<input type="checkbox"/>
<input type="checkbox"/>	Crystal AB CAL V SI (001 AB)	<input type="checkbox"/>	<input type="checkbox"/>
<input type="checkbox"/>	Crystal Copper CAL V SI (001 COP)	<input type="checkbox"/>	<input type="checkbox"/>
<input type="checkbox"/>	Crystal Golden Shadow CAL V SI (001 GSHA)	<input type="checkbox"/>	<input type="checkbox"/>
<input type="checkbox"/>	Crystal Silver Shade CAL V SI (001 SSHA) <i>New!</i>	<input type="checkbox"/>	<input type="checkbox"/>
<input type="checkbox"/>	Crystal Satin CAL V SI (001 SAT)	<input type="checkbox"/>	<input type="checkbox"/>
<input type="checkbox"/>	Jet (280)	<input type="checkbox"/>	<input type="checkbox"/>
<input type="checkbox"/>	Jet Hematite (280 HEM)	<input type="checkbox"/>	<input type="checkbox"/>
<input type="checkbox"/>	Jet Metallic Silver (280 METSI)	<input type="checkbox"/>	<input type="checkbox"/>
<input type="checkbox"/>	Jet Nut (280 NUT)	<input type="checkbox"/>	<input type="checkbox"/>

# Fancy Stones & Settings

## 4584 Chessboard Flat Fancy Stone

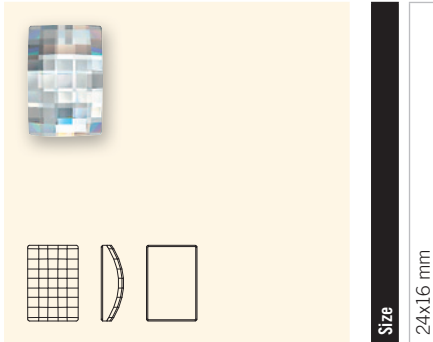

**Size**  
24x16 mm

Colour	
	Crystal CAL V SI (001)
	Crystal AB CAL V SI (001 AB)
	Crystal Copper CAL V SI (001 COP)
	Crystal Golden Shadow CAL V SI (001 GSHA)
	Crystal Silver Shade CAL V SI (001 SSHA) <i>New!</i>
	Crystal Satin CAL V SI (001 SAT)
	Jet (280)
	Jet Hematite (280 HEM)
	Jet Metallic Silver (280 METSI)
	Jet Nut (280 NUT)

## 4600

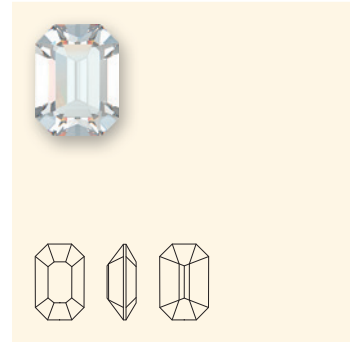

**Size**  
6x4 mm  
8x6 mm  
10x8 mm  
12x10 mm

Colour	
	Crystal F (001)
	Crystal AB F (001 AB) <i>New!</i>
	Crystal Golden Shadow F (001 GSHA) <i>New!</i>
	Crystal Silver Shade F (001 SSHA) <i>New!</i>
	Jet (280)
	Aquamarine F (202)
	Montana F (207)
	Rose F (209)
	Siam F (208)
	Topaz F (203)

01 Fancy Stones & Settings



# Fancy Stones & Settings

4610

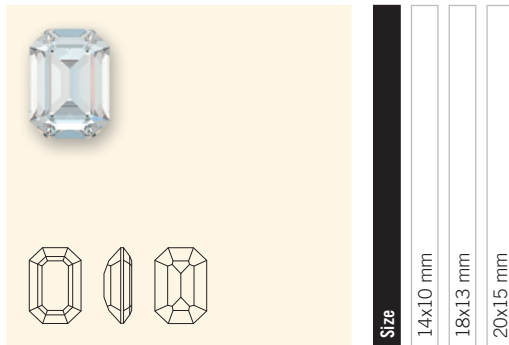

Colour	14x10 mm	18x13 mm	20x15 mm
Crystal F (001)	■	■	■
Crystal Golden Shadow F (001 GSHA)	■	■	■
Crystal Silver Shade F (001 SSHA)	■	■	■
Jet (280)	■	■	■
Amethyst F (204)	■	■	
Aquamarine F (202)	■	■	
Black Diamond F (215)	■	■	
Emerald F (205)	■	■	
Indian Sapphire F (217)	■	■	
Light Colorado Topaz F (246)	■	■	
Light Rose F (223)	■	■	
Montana F (207)	■	■	
Peridot F (214)	■	■	
Rose F (209)	■	■	
Siam F (208)	■	■	
Tanzanite F (539)	■	■	
Topaz F (203)	■	■	

4610/S

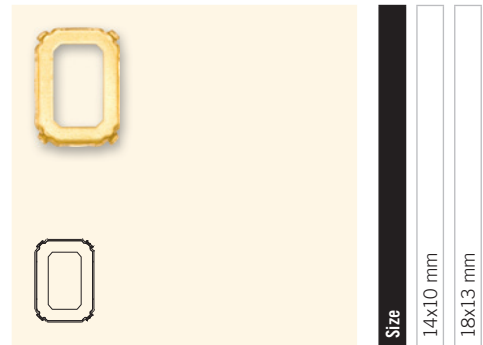

Ring/Hole, Back Configuration	14x10 mm	18x13 mm
<b>00 C</b> = No ring/hole, closed	■	■
<b>H2 O</b> = 4 holes/2 each side, open	■	■



# Fancy Stones & Settings

4627

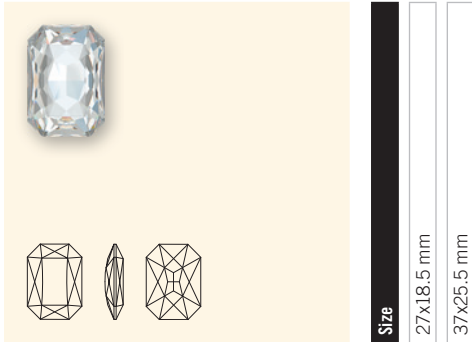

Size

27x18.5 mm

37x25.5 mm

**Colour**

	Crystal F (001)	<input type="checkbox"/>	<input type="checkbox"/>
	Crystal AB F (001 AB)	<input type="checkbox"/>	<input type="checkbox"/>
	Crystal Golden Shadow F (001 GSHA)	<input type="checkbox"/>	<input type="checkbox"/>
	Crystal Moonlight F (001 MOL)	<input type="checkbox"/>	<input type="checkbox"/>
	Crystal Red Magma F (001 REDM)	<input type="checkbox"/>	<input type="checkbox"/>
	Crystal Silver Shade F (001 SSHA)	<input type="checkbox"/>	<input type="checkbox"/>
	Crystal Vitrail Medium (001 VM)	<input type="checkbox"/>	<input type="checkbox"/>
	Jet (280)	<input type="checkbox"/>	<input type="checkbox"/>
	Jet Hematite (280 HEM)	<input type="checkbox"/>	<input type="checkbox"/>
	Jet Metallic Silver (280 METSI)	<input type="checkbox"/>	<input type="checkbox"/>
	Jet Nut (280 NUT)	<input type="checkbox"/>	<input type="checkbox"/>
	Amethyst F (204)	<input type="checkbox"/>	<input type="checkbox"/>
	Aquamarine F (202)	<input type="checkbox"/>	<input type="checkbox"/>
	Black Diamond F (215)	<input type="checkbox"/>	<input type="checkbox"/>
	Burgundy F (515)	<input type="checkbox"/>	<input type="checkbox"/>
	Chrysolite F (238)	<input type="checkbox"/>	<input type="checkbox"/>
	Emerald F (205)	<input type="checkbox"/>	<input type="checkbox"/>
	Fuchsia F (502)	<input type="checkbox"/>	<input type="checkbox"/>
	Light Colorado Topaz F (246)	<input type="checkbox"/>	<input type="checkbox"/>
	Light Rose F (223)	<input type="checkbox"/>	<input type="checkbox"/>
	Montana F (207)	<input type="checkbox"/>	<input type="checkbox"/>
	Tanzanite F (539)	<input type="checkbox"/>	<input type="checkbox"/>
	White Opal F (234)	<input type="checkbox"/>	<input type="checkbox"/>

4627/S

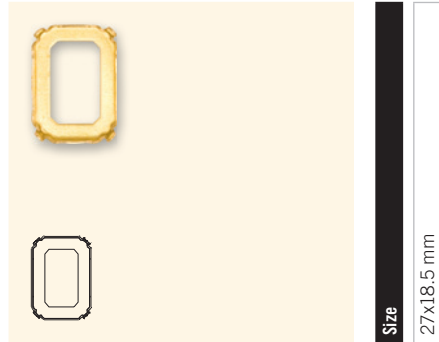

Size

27x18.5 mm

**Ring/Hole, Back Configuration**

<input type="checkbox"/>	00 C = No ring/hole, closed	<input type="checkbox"/>
<input type="checkbox"/>	H2 O = 4 holes/2 each side, open	<input type="checkbox"/>



01 Fancy Stones & Settings

# Fancy Stones & Settings

4675

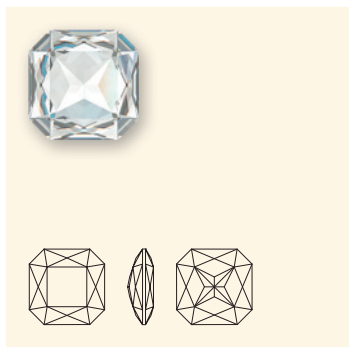

Size 23 mm

**Colour**

- Crystal F (001)
- Crystal AB F (001 AB)
- Crystal Golden Shadow F (001 GSHA)
- Crystal Red Magma F (001 REDM) *New!*
- Crystal Sahara F (280) *New!*
- Crystal Silver Shade F (001 SSHA)
- Crystal Vitrail Medium (001 VM)
- Jet (280)

4704 Mini Triangle Fancy Stone

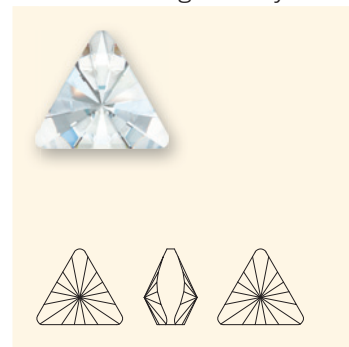

Size 5 mm

**Colour**

- Crystal F (001)
- Jet (280)
- Aquamarine F (202)
- Black Diamond F (215)
- Light Amethyst F (212)
- Light Colorado Topaz F (246)
- Light Rose F (223)
- Peridot F (214)

4722

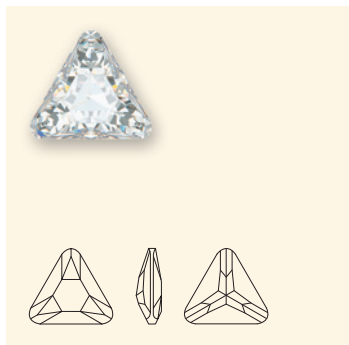

Size 4 mm 6 mm 8 mm 10 mm

**Colour**

- Crystal F (001)
- Crystal Golden Shadow F (001 GSHA) *New!*
- Crystal Silver Shade F (001 SSHA) *New!*

Fancy Stones & Settings

# Fancy Stones & Settings

4727

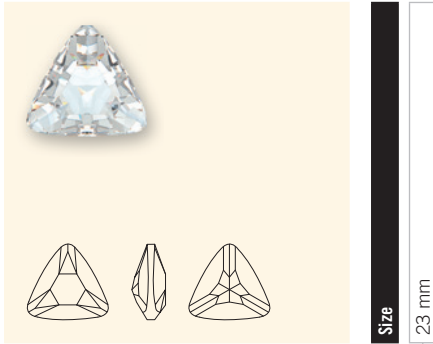

Size 23 mm

- Colour**
- Crystal F (001)
  - Crystal Golden Shadow F (001 GSHA)
  - Crystal Silver Shade F (001 SSHA)

4727/S

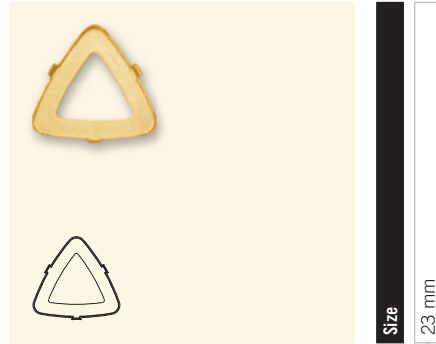

Size 23 mm

- Ring/Hole, Back Configuration**
- 00 C = No ring/hole, closed
  - H2 O = 4 holes/2 each side, open

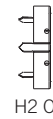

4735 Mini Blossom Fancy Stone

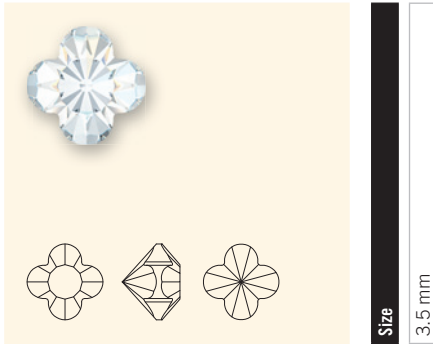

Size 3.5 mm

- Colour**
- Crystal F (001)
  - Aquamarine F (202)
  - Black Diamond F (215)
  - Dark Siam F (308) *New!*
  - Indian Siam F (327) *New!*
  - Light Amethyst F (212)
  - Light Colorado Topaz F (246)
  - Light Rose F (223)
  - Peridot F (214)

4737 Cosmic Triangle



Size 14 mm 20 mm 30 mm

- Colour**
- Crystal (001)
  - Crystal CAL V SI (001)
  - Crystal Bermuda Blue (001 BBL)
  - Crystal Copper (001 COP)
  - Crystal Copper CAL V SI (001 COP)
  - Crystal Dorado (001 DOR)
  - Crystal Golden Shadow (001 GSHA)
  - Crystal Golden Shadow CAL V SI (001 GSHA)
  - Crystal Red Magma (001 REDM)
  - Crystal Sahara (001 SAH)
  - Crystal Silver Shade (001 SSHA)
  - Crystal Silver Shade CAL V SI (001 SSHA)
  - Crystal Tabac (001 TAB)
  - Crystal Vitrail Light (001 VL)
  - Crystal Volcano (001 VOL)
  - Jet (280)
  - Jet Hematite (280 HEM) *New!*
  - White Opal (234) *New!*

Fancy Stones & Settings

# Fancy Stones & Settings

## 4739 Cosmic Fancy Stone



Size  
14x11 mm  
20x16 mm

Colour	
<input type="checkbox"/>	Crystal F (001)
<input type="checkbox"/>	Crystal Golden Shadow F (001 GSHA)
<input type="checkbox"/>	Crystal Red Magma F (001 REDM)
<input type="checkbox"/>	Crystal Silver Shade F (001 SSHA)
<input type="checkbox"/>	Jet (280)
<input type="checkbox"/>	Jet Hematite (280 HEM)
<input type="checkbox"/>	Aquamarine F (202)
<input type="checkbox"/>	Light Amethyst F (212)
<input type="checkbox"/>	Olivine F (228)
<input type="checkbox"/>	Rose F (209)
<input type="checkbox"/>	White Opal F (234)

## 4744 Flower Fancy Stone

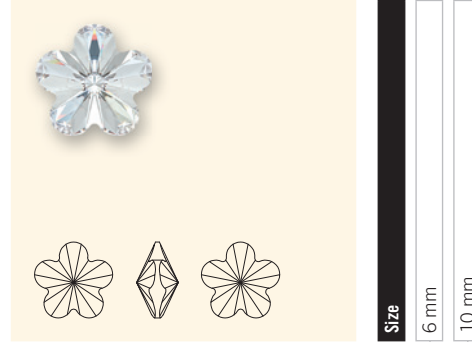

Size  
6 mm  
10 mm

Colour	
<input type="checkbox"/>	Crystal F (001)
<input type="checkbox"/>	Crystal AB F (001 AB)
<input type="checkbox"/>	Aquamarine F (202)
<input type="checkbox"/>	Fuchsia F (502)
<input type="checkbox"/>	Light Rose F (223)
<input type="checkbox"/>	Light Siam F (227)
<input type="checkbox"/>	Peridot F (214)
<input type="checkbox"/>	Violet F (371)

## 4745 Star Fancy Stone



Size  
5 mm  
10 mm

Colour	
<input type="checkbox"/>	Crystal F (001)
<input type="checkbox"/>	Crystal AB F (001 AB)
<input type="checkbox"/>	Crystal Bermuda Blue F (001 BBL)
<input type="checkbox"/>	Crystal Golden Shadow F (001 GSHA)
<input type="checkbox"/>	Crystal Silver Shade F (001 SSHA)
<input type="checkbox"/>	Crystal Vitrail Light F (001 VL)
<input type="checkbox"/>	Crystal Vitrail Medium F (001 VM)
<input type="checkbox"/>	Jet (280)
<input type="checkbox"/>	Jet Hematite (280 HEM)

## 4756 Galactic Flat Fancy Stone

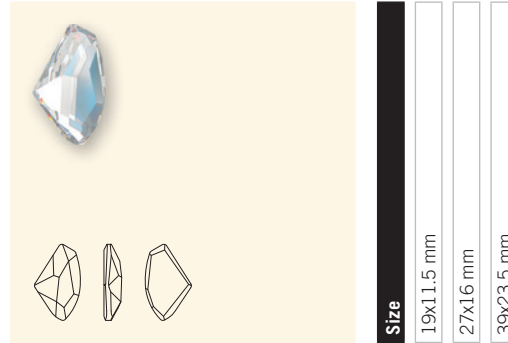

Size  
19x11.5 mm  
27x16 mm  
39x23.5 mm

Colour	
<input type="checkbox"/>	Crystal F (001)
<input type="checkbox"/>	Crystal Golden Shadow F (001 GSHA)
<input type="checkbox"/>	Crystal Red Magma F (001 REDM)
<input type="checkbox"/>	Crystal Sahara F (001 SAH)
<input type="checkbox"/>	Crystal Silver Shade F (001 SSHA)
<input type="checkbox"/>	Jet (280)
<input type="checkbox"/>	Jet Hematite (280 HEM)

# Fancy Stones & Settings

01 Fancy Stones & Settings

## 4757 Galactic Fancy Stone

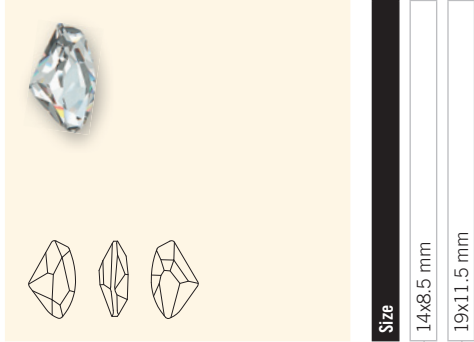

Colour		Size
<input type="checkbox"/>	Crystal F (001)	14x8.5 mm
<input type="checkbox"/>	Crystal Golden Shadow F (001 GSHA) <i>New!</i>	19x11.5 mm
<input type="checkbox"/>	Crystal Silver Shade F (001 SSHA) <i>New!</i>	
<input type="checkbox"/>	Jet (280)	
<input type="checkbox"/>	Jet Hematite (280 HEM) <i>New!</i>	
<input type="checkbox"/>	Aquamarine F (202)	
<input type="checkbox"/>	Light Colorado Topaz F (246)	
<input type="checkbox"/>	Light Rose F (223)	
<input type="checkbox"/>	Tanzanite F (539)	
<input type="checkbox"/>	White Opal F (234)	

## 4759 Cosmic Flat Fancy Stone

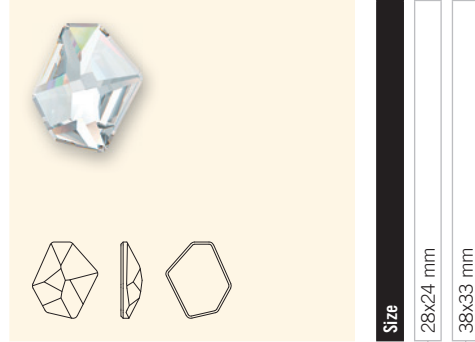

Colour		Size
<input type="checkbox"/>	Crystal F (001)	28x24 mm
<input type="checkbox"/>	Crystal Golden Shadow F (001 GSHA)	38x33 mm
<input type="checkbox"/>	Crystal Sahara F (280)	
<input type="checkbox"/>	Crystal Silver Shade F (001 SSHA)	
<input type="checkbox"/>	Jet (280)	
<input type="checkbox"/>	Jet Hematite (280 HEM) <i>New!</i>	

## 4760 Calypso Fancy Stone

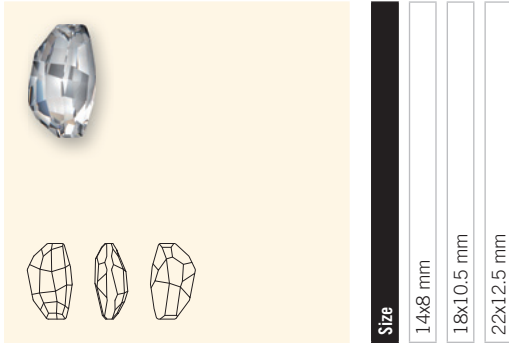

Colour		Size
<input type="checkbox"/>	Crystal F (001)	14x8 mm
<input type="checkbox"/>	Crystal AB F (001 AB)	18x10.5 mm
<input type="checkbox"/>	Crystal Copper F (001 COP)	22x12.5 mm
<input type="checkbox"/>	Crystal Golden Shadow F (001 GSHA)	
<input type="checkbox"/>	Crystal Red Magma F (001 REDM)	
<input type="checkbox"/>	Crystal Silver Shade F (001 SSHA)	
<input type="checkbox"/>	Jet (280)	
<input type="checkbox"/>	Jet Nut (280 NUT)	
<input type="checkbox"/>	Aquamarine F (202)	
<input type="checkbox"/>	Light Rose F (223)	
<input type="checkbox"/>	Olivine F (228)	
<input type="checkbox"/>	Provence Lavender F (283)	

## 4760/S *New!*

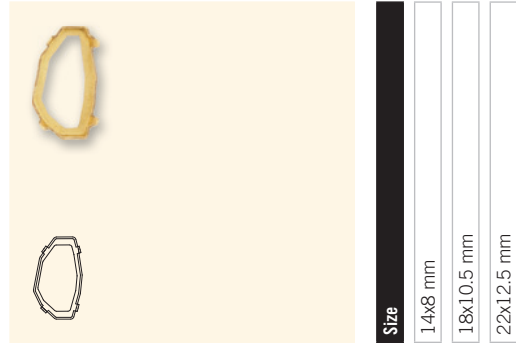

Ring/Hole, Back Configuration		Size
<input type="checkbox"/>	00 C = No ring/hole, closed	14x8 mm
<input type="checkbox"/>	H2 O = 4 holes/2 each side, open	18x10.5 mm
<input type="checkbox"/>		22x12.5 mm

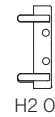

# Fancy Stones & Settings

## 4787 Divine Rock Flat Fancy Stone



Colour		Size	
<input type="checkbox"/>	Crystal F (001)	19x13 mm	27x19 mm
<input type="checkbox"/>	Crystal Golden Shadow F (001 GSHA)		
<input type="checkbox"/>	Crystal Red Magma F (001 REDM)		
<input type="checkbox"/>	Crystal Silver Shade F (001 SSHA)		
<input type="checkbox"/>	Jet (280)		
<input type="checkbox"/>	Aquamarine F (202)		
<input type="checkbox"/>	Jonquil F (213)		
<input type="checkbox"/>	Light Rose F (223)		
<input type="checkbox"/>	Montana F (207)		
<input type="checkbox"/>	Topaz F (203)		

## 4790 Wing Fancy Stone



Colour		Size		
<input type="checkbox"/>	Crystal F (001)	18x7.5 mm	23x10 mm	32x13.5 mm
<input type="checkbox"/>	Crystal AB F (001 AB)			
<input type="checkbox"/>	Crystal Copper F (001 COP)			
<input type="checkbox"/>	Crystal Golden Shadow F (001 GSHA)			
<input type="checkbox"/>	Crystal Red Magma F (001 REDM)			
<input type="checkbox"/>	Crystal Silver Shade F (001 SSHA)			
<input type="checkbox"/>	Jet (280)			
<input type="checkbox"/>	Aquamarine F (202)			
<input type="checkbox"/>	Fuchsia F (202)			
<input type="checkbox"/>	Light Rose F (223)			
<input type="checkbox"/>	Light Topaz F (226)			
<input type="checkbox"/>	Peridot F (214)			
<input type="checkbox"/>	Tanzanite F (539)			
<input type="checkbox"/>	Provence Lavender F (283)			

## 4790/S <sup>New!</sup>

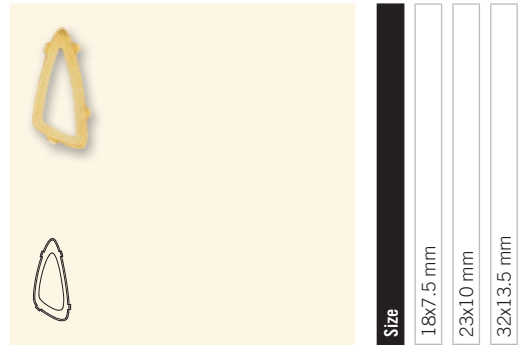

Ring/Hole, Back Configuration		Size		
<input type="checkbox"/>	00 C = No ring/hole, closed	18x7.5 mm	23x10 mm	32x13.5 mm
<input type="checkbox"/>	H2 O = 4 holes/2 each side, open			

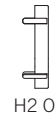
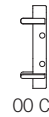



# Fancy Stones & Settings

## 4800 Heart Fancy Stone



Size
5.5x5 mm
6.6x6 mm
8.8x8 mm
11x10 mm
15.4x14 mm

### Colour

Crystal F (001)	■	■	■	■	■
Crystal AB F (001 AB)	■	■	■	■	■
Jet (280)	■	■	■	■	■
Amethyst F (204)	■	■	■	■	■
Aquamarine F (202)	■	■	■	■	■
Black Diamond F (215)	■	■	■	■	■
Emerald F (205)	■	■	■	■	■
Light Amethyst F (212)	■	■	■	■	■
Light Rose F (223)	■	■	■	■	■
Light Siam F (227)	■	■	■	■	■
Montana F (207)	■	■	■	■	■
Peridot F (214)	■	■	■	■	■
Rose F (209)	■	■	■	■	■
Sapphire F (206)	■	■	■	■	■
Siam F (208)	■	■	■	■	■
Topaz F (203)	■	■	■	■	■

01 Fancy Stones & Settings

# Fancy Stones & Settings

4827

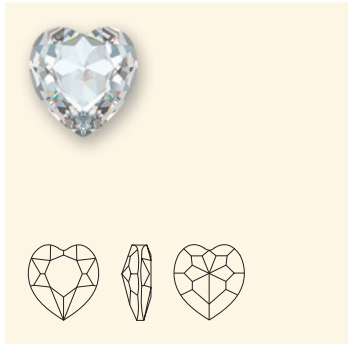

Size  
28 mm

**Colour**

- Crystal F (001)
- Crystal AB F (001 AB)
- Crystal Bermuda Blue (001 BBL)
- Crystal Golden Shadow F (001 GSHA)
- Crystal Red Magma F (001 REDM)
- Crystal Silver Shade F (001 SSHA)
- Crystal Vitrail Medium (001 VM)
- Amethyst F (204)
- Fuchsia F (502)
- Light Amethyst F (212) *New!*
- Light Rose F (223)
- Provence Lavender F (283)

4827/S

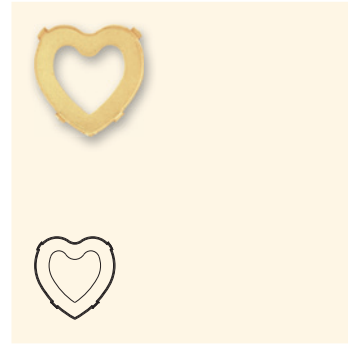

Size  
28 mm

**Ring/Hole, Back Configuration**

- 00 C = No ring/hole, closed
- H2 O = 4 holes/2 each side, open

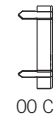

4831 Antique Heart Fancy Stone

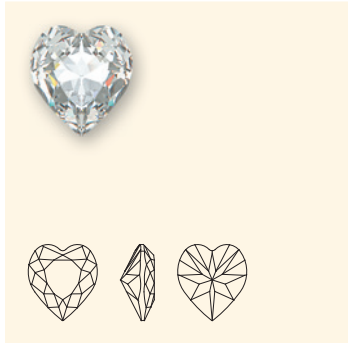

Size  
5.5x5 mm  
8.8x8 mm  
11x10 mm

**Colour**

- Crystal F (001)
- Light Amethyst F (212) *New!*
- Light Rose F (223) *New!*
- Light Siam F (227) *New!*
- Rose F (209)
- Siam F (208)

4835 Mini Heart Fancy Stone

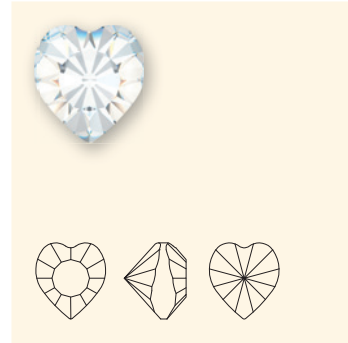

Size  
3.5 mm

**Colour**

- Crystal F (001)
- Aquamarine F (202)
- Black Diamond F (215)
- Dark Siam F (308) *New!*
- Indian Siam F (327) *New!*
- Light Amethyst F (212)
- Light Colorado Topaz F (246)
- Light Rose F (223)
- Peridot F (214)

# Fancy Stones & Settings

01 Fancy Stones & Settings

4841

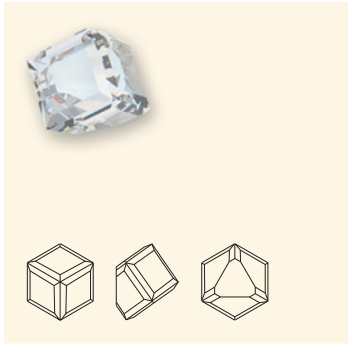

Size	4 mm	6 mm	8 mm
------	------	------	------

Colour	
<input type="checkbox"/>	Crystal CAL VZ SI (001)
<input type="checkbox"/>	Crystal AB CAL VZ SI (001 AB)
<input type="checkbox"/>	Crystal Bermuda Blue Z (001 BBL)
<input type="checkbox"/>	Crystal Golden Shadow CAL VZ SI (001 GSHA)
<input type="checkbox"/>	Crystal Heliotrope Z (001 HEL)
<input type="checkbox"/>	Crystal Vitrail Light Z (001 VL)
<input type="checkbox"/>	Crystal Vitrail Medium Z (001 VM)
<input type="checkbox"/>	Aquamarine CAL VZ SI (202)
<input type="checkbox"/>	Light Rose CAL VZ SI (223)
<input type="checkbox"/>	Light Siam CAL VZ SI (227)
<input type="checkbox"/>	Peridot CAL VZ SI (214)
<input type="checkbox"/>	Violet CAL VZ SI (371)

4842 Pyramid Fancy Stone

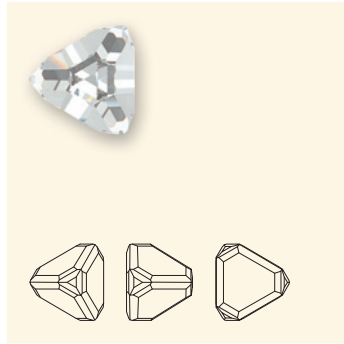

Size	4 mm	6 mm
------	------	------

Colour	
<input type="checkbox"/>	Crystal CAL V SI (001)

4854 Space Cut Fancy Stone

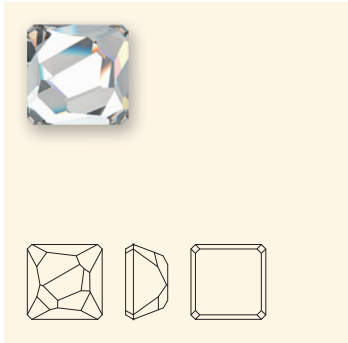

Size	6 mm	8 mm	10 mm
------	------	------	-------

Colour	
<input type="checkbox"/>	Crystal CAL V SI (001)
<input type="checkbox"/>	Crystal AB CAL V SI (001 AB)
<input type="checkbox"/>	Crystal Golden Shadow CAL V SI (001 GSHA)
<input type="checkbox"/>	Jet (280)
<input type="checkbox"/>	Jet Hematite (280 HEM)

4869

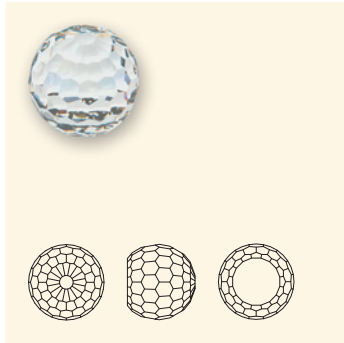

Size	4 mm	6 mm	8 mm	10 mm	12 mm	14 mm
------	------	------	------	-------	-------	-------

Colour	
<input type="checkbox"/>	Crystal CAL VZ SI (001)
<input type="checkbox"/>	Crystal AB CAL VZ SI (001 AB)
<input type="checkbox"/>	Crystal Vitrail Light Z (001 VL)
<input type="checkbox"/>	Crystal Vitrail Medium Z (001 VM)
<input type="checkbox"/>	Aquamarine CAL VZ SI (202)
<input type="checkbox"/>	Light Rose CAL VZ SI (223)
<input type="checkbox"/>	Light Siam CAL VZ SI (227)
<input type="checkbox"/>	Violet CAL VZ SI (371)
<input type="checkbox"/>	White Opal CAL VZ SI (234)

Article Size	Packing Unit = Minimum Order Quantity in Pieces	Average Net Weight in Gram per Packing Unit Crystal (001)	Average Gross Weight in Gram per Packing Unit Crystal (001)
<b>4120</b>			
6x4 mm	360	26.1	37.0
8x6 mm	180	37.4	46.5
14x10 mm	144	142.5	166.1
18x13 mm	48	94.0	114.6
25x18 mm	24	127.4	152.8
<b>4120/S</b>			
14x10 mm	144		86.0
18x13 mm	48		49.5
<b>4127</b>			
30x22 mm	24	145.3	190.4
39x28 mm	12	189.8	209.4
<b>4127/S</b>			
30x22 mm	24		53.0
<b>4128*</b>			
6x4 mm	360	26.8	37.6
8x6 mm	360	76.5	87.3
10x8 mm	144	59.9	80.2
14x10 mm	144	105.6	129.2
<b>4128/S*</b>			
14x10 mm	144		86.0
<b>4137</b>			
15x11 mm	72	48.2	66.4
22x16 mm	24	44.2	64.2
33x24 mm	18	117.5	144.2
<b>4139</b>			
14 mm	72	53.2	82.7
20 mm	24	46.7	78.7
30 mm	18	124.6	153.0
<b>4161</b>			
15x5 mm	72	24.7	42.8
21x7 mm	48	59.9	84.9
27x9 mm	24	55.1	83.5
<b>4161/S</b>			
15x5 mm	72		24.3
21x7 mm	48		27.0
27x9 mm	24		21.5
<b>4200</b>			
11x3 mm	360	28.6	39.4
15x4 mm	144	26.2	37.1
<b>4227</b>			
32x17 mm	24	100.8	123.4
<b>4227/S</b>			
32x17 mm	24		48.0
<b>4228</b>			
4x2 mm	720	9.2	18.3
5x2.5 mm	720	18.9	28.0
6x3 mm	720	30.5	39.6
8x4 mm	360	32.9	42.0
10x5 mm	360	60.7	72.1
15x7 mm	144	63.9	88.1

\* Available as of September 2010! Until September 2010 art. 4100 is still available (please refer to former Collection for product details).



# Fancy Stones & Settings

Article Size	Packing Unit = Minimum Order Quantity in Pieces	Average Net Weight in Gram per Packing Unit Crystal (001)	Average Gross Weight in Gram per Packing Unit Crystal (001)
<b>4320</b>			
6x4 mm	360	25.7	34.8
8x6 mm	180	30.7	39.8
10x7 mm	144	48.6	68.9
14x10 mm	144	126.6	150.2
18x13 mm	48	85.2	105.8
<b>4320/S</b>			
18x13 mm	48		46.0
<b>4327</b>			
30x20 mm	24	135.4	180.5
40x27 mm	12	168.7	193.4
<b>4327/S</b>			
30x20 mm	24		51.5
<b>4328</b>			
6x3.6 mm	720	40.0	50.5
8x4.8 mm	360	42.1	53.0
10x6 mm	144	29.2	50.5
13x7.8 mm	144	65.1	88.3
<b>4335</b>			
3.5 mm	1,440	43.3	49.2
<b>4370</b>			
11x10 mm	144	82.8	100.9
15.5x14 mm	72	107.3	127.4
20x18 mm	48	149.5	170.0
<b>4428</b>			
2 mm	1,440	10.3	21.0
3 mm	1,440	36.7	50.5
4 mm	1,440	90.8	101.8
5 mm	360	43.2	53.5
6 mm	360	74.1	78.4
8 mm	144	70.7	85.9
<b>4428/S</b>			
6 mm	360		50.0
8 mm	144		45.5
<b>4437</b>			
14 mm	72	48.2	78.7
20 mm	30	57.8	86.1
30 mm	18	105.5	159.8
<b>4439</b>			
14 mm	72	88.0	111.6
20 mm	24	80.4	123.0
30 mm	12	127.6	145.8
<b>4447</b>			
6 mm	360	73.2	84.0
8 mm	144	59.8	80.2
10 mm	144	112.1	135.4
12 mm	72	98.5	118.7
<b>4447/S</b>			
6 mm	360		50.0
8 mm	144		47.0
10 mm	144		70.5
12 mm	72		56.0

# Fancy Stones & Settings

Article Size	Packing Unit = Minimum Order Quantity in Pieces	Average Net Weight in Gram per Packing Unit Crystal (001)	Average Gross Weight in Gram per Packing Unit Crystal (001)
<b>4461</b>			
8 mm	144	56.9	77.2
12 mm	72	84.4	103.4
16 mm	72	214.4	238.0
<b>4461/S</b>			
12 mm	72		52.8
16 mm	72		92.0
<b>4470</b>			
10 mm	144	91.6	111.9
12 mm	72	74.7	92.9
18 mm	48	170.3	190.9
<b>4470/S</b>			
10 mm	144		54.5
12 mm	72		53.3
<b>4500</b>			
3x2 mm	1,440	20.5	32.0
6x2 mm	720	18.4	27.5
10x3 mm	360	36.6	47.6
<b>4501</b>			
4x2 mm	720	16.8	25.9
5x2 mm	720	18.1	27.2
5x2.5 mm	720	20.9	30.0
7x3 mm	720	60.2	71.1
10x5 mm	360	96.2	106.9
<b>4501/S</b>			
7x3 mm	720		58.0
<b>4502</b>			
3x1 mm	720	2.2	11.4
<b>4527</b>			
8x6 mm	144	44.9	55.8
14x10 mm	72	95.8	114.0
18x13 mm	72	206.7	230.4
<b>4527/S</b>			
8x6 mm	144		45.5
14x10 mm	72		60.3
<b>4547</b>			
15x5 mm	72	31.3	49.4
21x7 mm	48	54.6	88.1
24x8 mm	48	81.6	114.6
30x10 mm	24	82.2	99.7
<b>4547/S</b>			
15x5 mm	72		36.8
21x7 mm	48		43.5
24x8 mm	48		50.5
30x10 mm	24		39.0
<b>4565</b>			
14x10 mm	72	71.5	88.9
18x13 mm	48	101.2	121.8
<b>4581</b>			
24x16 mm	20	118.9	146.7
<b>4582</b>			
24x16 mm	20	112.2	139.4



# Fancy Stones & Settings

Article Size	Packing Unit = Minimum Order Quantity in Pieces	Average Net Weight in Gram per Packing Unit Crystal (001)	Average Gross Weight in Gram per Packing Unit Crystal (001)
<b>4583</b>			
24x16 mm	20	127.2	155.0
<b>4584</b>			
24x16 mm	20	107.1	135.8
<b>4600</b>			
6x4 mm	360	40.9	51.8
8x6 mm	144	41.2	52.2
10x8 mm	144	84.0	104.0
12x10 mm	144	146.7	170.3
<b>4610</b>			
14x10 mm	144	171.3	194.9
18x13 mm	48	124.9	145.5
20x15 mm	24	88.5	105.8
<b>4610/S</b>			
14x10 mm	144		104.5
18x13 mm	48		66.0
<b>4627</b>			
27x18.5 mm	24	125.3	170.8
37x25.5 mm	12	170.7	197.8
<b>4627/S</b>			
27x18.5 mm	24		54.0
<b>4675</b>			
23 mm	24	146.8	191.9
<b>4704</b>			
5 mm	720	58.5	67.8
<b>4722</b>			
4 mm	480	12.0	21.1
6 mm	180	16.4	25.5
8 mm	144	29.0	48.1
10 mm	144	61.4	84.4
<b>4727</b>			
23 mm	24	131.8	176.8
<b>4727/S</b>			
23 mm	24		41.0
<b>4735</b>			
3.5 mm	1,440	45.5	48.7
<b>4737</b>			
14 mm	48	36.2	53.9
20 mm	20	55.2	73.5
30 mm	12	89.4	109.2
<b>4739</b>			
14x11 mm	144	120.3	146.9
20x16 mm	72	168.0	197.0
<b>4744</b>			
6 mm	720	62.3	72.8
10 mm	288	126.0	158.1
<b>4745</b>			
5 mm	720	35.6	46.4
10 mm	144	48.5	71.3



# Fancy Stones & Settings

Article Size	Packing Unit = Minimum Order Quantity in Pieces	Average Net Weight in Gram per Packing Unit Crystal (001)	Average Gross Weight in Gram per Packing Unit Crystal (001)
<b>4756</b>			
19x11.5 mm	96	112.5	149.4
27x16 mm	40	127.2	169.2
39x23.5 mm	24	221.0	256.2
<b>4757</b>			
14x8.5 mm	96	64.3	83.5
19x11.5 mm	96	152.7	181.9
<b>4759</b>			
28x24 mm	20	102.5	128.7
38x33 mm	12	153.7	178.7
<b>4760</b>			
14x8 mm	144	132.6	145.8
18x10.5 mm	96	168.7	204.7
22x12.5 mm	36	126.6	154.2
<b>4760/S</b>			
14x8 mm	144		105.1
18x10.5 mm	96		107.0
22x12.5 mm	36		59.4
<b>4787</b>			
19x13 mm	48	108.5	127.0
27x19 mm	30	208.4	240.7
<b>4790</b>			
18x7.5 mm	108	72.3	97.1
23x10 mm	36	48.2	71.9
32x13.5 mm	30	105.5	139.5
<b>4790/S</b>			
18x7.5 mm	108		85.9
23x10 mm	36		47.7
32x13.5 mm	30		75.5
<b>4800</b>			
5.5x5 mm	360	39.0	49.7
6.6x6 mm	360	67.2	78.0
8.8x8 mm	288	111.4	138.1
11x10 mm	144	107.3	127.4
15.4x14 mm	72	128.7	149.3
<b>4827</b>			
28 mm	24	214.9	253.3
<b>4827/S</b>			
28 mm	24		55.5
<b>4831</b>			
5.5x5 mm	360	26.5	37.3
8.8x8 mm	144	40.0	60.4
11x10 mm	144	80.1	101.5
<b>4835</b>			
3.5 mm	1,440	48.2	54.0
<b>4841</b>			
4 mm	288	45.3	66.6
6 mm	144	77.2	95.3
8 mm	72	89.2	107.4
<b>4842</b>			
4 mm	288	31.6	52.9
6 mm	288	109.9	140.7



# Fancy Stones & Settings

Article Size	Packing Unit = Minimum Order Quantity in Pieces	Average Net Weight in Gram per Packing Unit Crystal (001)	Average Gross Weight in Gram per Packing Unit Crystal (001)
<b>4854</b>			
6 mm	288	59.9	80.2
8 mm	144	72.3	90.3
10 mm	72	69.9	87.6
<b>4869</b>			
4 mm	480	36.2	45.3
6 mm	180	47.2	56.4
8 mm	144	90.8	109.0
10 mm	72	88.3	105.3
12 mm	48	109.3	129.6
14 mm	72	269.4	296.8

